



Heinzmann GmbH & Co. KG
Electric drives

Am Haselbach 1
D-79677 Schönau

Phone+49 (0) 76738208-0
Fax+49 (0) 76738208-188
E-mail info@heinzmann.com
www.heinzmann-electric-motors.com

USt-IdNr.:DE145551926

HEINZMANN®

Electric drives





Drives for light electric vehicles

Drive system
CargoPower

**Technical information on
installation and operation**

(translated version)

Revision - 01

	<p>Before installation, commissioning or maintenance, the relevant manuals must be read in their entirety.</p> <p>All instructions concerning the installation and safety must be followed. Failure to follow the instruction may result in personal injury and/or damage to property.</p> <p>HEINZMANN accepts no liability for damage caused by failure to follow instructions.</p> <p>Independent testing and verification is of particular importance in all applications where malfunction may result in personal injury or property damage.</p>
	<p>All examples and data, as well as all other information in this manual are for instructional purposes only and must not be used for any specific application without independent testing and verification by the user.</p> <p>HEINZMANN makes no warranty, express or implied, that the examples, data or other information in this manual are error-free, conform to industry standards or meet the needs of any particular application.</p>
	<p>Before installation, the following must be observed:</p> <p>Always disconnect the system from the power supply before working on it! Only use cable shielding and power supply connections that comply with the European Directive regarding EMC.</p> <p>Check the function of all existing protection and monitoring systems.</p>
	<p>As soon as an electrical drive system is supplied with voltage, it can start moving at any time, depending on the circumstances. Any potential danger area must therefore be secured against unauthorized access.</p>
	<p>HEINZMANN expressly disclaims any implied warranty of tradeability or fitness for a particular purpose, even in the event that HEINZMANN's attention has been drawn to a particular purpose or that a particular purpose is referred to in the manual.</p>
	<p>HEINZMANN disclaims all liability for direct, indirect, incidental or consequential damages arising out of any use of the examples, data or other information contained in this manual.</p>
	<p>HEINZMANN accepts no responsibility for the design and planning of the overall technical system. This is the responsibility of the operator or their planners and specialist engineers. It is also their responsibility to check whether the performance of the HEINZMANN equipment is adequate for the intended purpose. The operator is also responsible for proper commissioning of the overall system.</p>

Version index

Revision	Date	Name	Comments
01	27-06-2023	WaJ/HaF	Translated version of document F_22_003_d_03_23_“CargoPower_Info_Einbau_Betrieb_10034.pdf”



HEINZMANN reserves the right to make changes in the course of technical development.

Table of Contents

1 Safety instructions and symbols used for them	1
2 Warnings and safety	2
2.1 Intended use	2
2.2 Driving licence, registration, insurance	2
2.3 General safety	3
2.4 Requirements for the installation of the CargoPower drive system.....	4
2.5 Transport and handling of the motor	5
3 Installation of the drive set.....	7
3.1 Installation of the controller box.....	7
3.1.1 Fastening the controller box	7
3.1.2 Installation location and position of the controller box, cable routing	8
3.2 Installation of the motor	9
3.2.1 Torque support.....	10
3.2.2 Motor cable routing	11
3.2.3 Brake disks	12
3.2.4 Brake disk initial assembly and change	13
3.2.5 Sprocket assembly	16
4 Peripherals.....	17
4.1 Pedal sensors	18
4.1.1 Speed sensor	18
4.1.2 Torque sensor	19
4.2 HMI and display	21
4.3 Throttle grip and thumb throttle	23
4.4 Buttons for further functions	24
4.4.1 Button for starting aid or reversing:.....	24
4.4.2 Starting aid function:	24
4.4.3 Reverse function:.....	24
4.5 Batteries.....	25
4.5.1 Batteries without communication	25
4.5.2 Batteries with CAN communication.....	26
4.6 Wiring and connections.....	26
4.6.1 Notes on EMC.....	26
4.6.2 CargoPower System	27
4.6.3 CargoTwinPower System	28
4.6.4 CargoTwinPower system with one battery.....	29
5 System FREE DRIVE®.....	30
5.1.1 CargoPower FREE DRIVE® System.....	31
5.1.2 CargoTwinPower FREE DRIVE® System	32
5.2 Installation of the FREE DRIVE® alternator.....	33
5.3 Using the HMI Cargo Remote.....	34
5.3.1 Key assignment	34
5.3.2 System Start.....	35
5.3.3 Support levels	35
5.3.4 Battery charge level indicator	35

5.3.5 Gear selection and transmission ratio	36
5.3.6 Change between CVT and manual transmission	37
6 System settings and service software	38
6.1 Configuration Suite	38
6.1.1 Installation of the Configuration Suite	38
6.1.2 Driver installation	38
6.1.3 Starting and setting up the Configuration Suite	39
6.1.4 Establish communication	42
6.1.5 Structure of the development dashboard	46
6.1.6 Functions of the Configuration Suite	50
6.2 Braking and recuperation	60
7 Maintenance, repair and cleaning	61
7.1 Oil filling	61
7.2 Repairs and service	62
7.3 Cleaning	63
8 Spoking the CargoPower motor RN 111	64
8.1 Rims	64
8.2 Spoke diameter	64
8.3 Spoke lengths	64
8.4 Spoke pattern and spoke tensions	65
8.4.1 Spoking symmetrical wheels	65
8.4.2 Spoking non-symmetrical wheels	66
8.4.3 Spoke pattern for rear wheel, rim 26" or rim 28", 1× crossed	67
8.4.4 Spoke pattern for front wheel, rim 26" or 28", 1× crossed	68
8.4.5 Spoke pattern for front wheel, rim 20" or 24", without crossing	68
8.4.6 Spoke pattern for rear wheel, rim 20" or 24", without crossing	68
9 Index	69

Downloads and links:

- Electric drive system for bicycles, cargo bikes and light vehicles



<https://www.heinzmann-electric-motors.com/produkte/fahrrad-radnabenmotoren/cargopower>



<https://www.heinzmann-electric-motors.com/downloads>

1 Safety instructions and symbols used for them

In the following document, specific warnings are given to point out the unavoidable residual risks when operating the machine. These residual risks imply dangers to

- People
- Product and machine
- Environment

The most important aim of the warnings is to prevent personal injury!

The signal words used in the print are primarily intended to draw attention to the possible extent of damage!

 **DANGER** indicates a hazardous situation which, if not avoided, will result in death or serious injury.

 **WARNING** indicates a hazardous situation which, if not avoided, could result in death or serious injury.

 **CAUTION** indicates a hazardous situation which, if not prevented, may result in minor injury.

 **NOTICE** indicates possible damage to property.



In addition to the signal word, safety instructions are also marked by triangular warning symbols. In some cases, round command symbols supplement the warnings. The symbols are intended to illustrate the danger and the protective measure.



In any case, the symbols cannot replace the text of the safety notice. The text must therefore always be read in full!



This symbol does not indicate safety instructions, but provides important information for a better understanding of the functions. These should be observed and adhered to without fail

2 Warnings and safety

Before using the product, these instructions must be read completely!

Keep the instructions in a safe place! If the product is passed on to a third party, the instructions must also be handed over.

Failure to follow these instructions may result in injury or damage to the product. The manufacturer accepts no liability for damage resulting from non-compliance with these instructions.

2.1 Intended use

The CargoPower drive system is used as a wheel hub drive for equipping electro motor-assisted wheels in accordance with DIN EN 15194:2018-11 and DIN EN 79010:2020 such as EPAC ("electrically power assisted cycle").

Permissible ambient temperature: -15 ... +40 °C

The following in particular do not count as intended use:

- Combination with components not approved by HEINZMANN
- Improper modifications or modifications not approved by HEINZMANN to the components of the drive system.
- Overstressing the motor due to vehicle racing or forcibly blocking the rotating motor, e.g. when driving against obstacles.
- hands-free driving

2.2 Driving licence, registration, insurance

For the use and operation of electrically assisted vehicles, any legal regulations applicable at the place of use must be observed.

These can be, for example:

- Traffic regulations
- Registration regulations for vehicles
- Insurance obligations
- Compulsory helmet





It is the responsibility of the operator or user of the vehicle to inform himself about the applicable legal regulations, to apply them and to comply with them. HEINZMANN declines any responsibility in this regard.

2.3 General safety

⚠ WARNING	Risk of breakage due to damaged or incorrectly mounted motor
	<p>A damaged or incorrectly mounted motor can cause load-bearing parts to break! This may result in a fall!</p> <ul style="list-style-type: none"> > Do not undertake any further journeys > Replace damaged motor immediately > When fitting the drive wheel, tighten the wheel nuts to the specified tightening torque!

⚠ WARNING	Danger due to unforeseen motor activity and rotating parts
	<p>The motor may start moving unexpectedly if the drive system is left on while working on the vehicle. Limbs or clothing may be drawn into rotating parts. This can result in injuries.</p> <ul style="list-style-type: none"> > Remove the battery before any work on the vehicle. > When putting the vehicle back into operation after assembly or repair, position it so that the drive wheel can rotate freely. Only then reinsert the battery and check the proper function of the drive.

⚠ CAUTION	Hot surfaces
 	<p>Danger of burns from hot motor during operation!</p> <ul style="list-style-type: none"> > Do not touch surfaces of the drive system during and up to 30 minutes after use. > If interventions are nevertheless unavoidable, wear suitable protective gloves

⚠ CAUTION	Fire hazard
	<p>Damaged electrical assemblies or cables can lead to short circuits! This can result in fires!</p> <ul style="list-style-type: none"> > Replace damaged electrical assemblies or cables immediately

⚠ CAUTION	Unauthorized use
	<p>Due to unforeseen events or unauthorized use, the vehicle may start moving unexpectedly! This may result in personal injury or damage to property!</p> <ul style="list-style-type: none"> > Always switch off the drive system when parking and leaving the vehicle

⚠ CAUTION	Unfamiliar driving behaviour
	<p>Vehicles assisted by electric motors behave differently when driving than those driven by pure muscle power. Lack of routine and/or experience can result in personal injury or property damage!</p> <p>> Practice using an electric motor-assisted vehicle sufficiently outside of public transport.</p>

2.4 Requirements for the installation of the CargoPower drive system

⚠ WARNING	Risk of breakage
	<p>Installation of the drive system in vehicles that are not sufficiently stable can cause load-bearing parts to break during operation! This may result in a fall!</p> <p>> Only install the RN 111 motor in forks and frames, which can withstand use with electric auxiliary drive up to at least 113 Nm!</p>

Requirements for fork and vehicle frame

Fork and frame of the vehicle:

- must at least comply with DIN EN 15194:2018-11 or DIN EN 79010:2020
- must not be warped
- must have dropouts of sufficient size to ensure safe and reliable attachment of the motor axle and especially the torque arm. A washer must be fitted between the wheel nuts and the dropouts, a washer must be fitted.

Required installation widths of fork and frame:

Front wheel (VR):	100 mm
Rear wheel (HR):	135 mm

Permissible axle loads:

Front wheel 880-00-181-XX:	max. 150 kg
Rear wheel 880-00-180-XX:	max. 125 kg
Single-sided suspension 880-00-182-XX:	max. 100 kg



The vehicle body has a great influence on the dynamic forces during operation. Therefore, the actual possible axle load may differ from that given here. For example, the dynamic lateral forces that occur are significantly higher if the motors are installed in the wheels of a steerable axle.

2.5 Transport and handling of the motor



In the event of temperature fluctuations or fluctuations in the ambient air pressure (e.g. during air transport), a pressure equalization between the motor casing and the environment happens. This can cause a negligible amount of oil to leak from the motor. Therefore, always transport and store the motor upright, as in its installation position, and do not leave it permanently in a lying position. During transport the axle stub and torque support or alternatively the transport lock (see following sketch) must be fitted.



Remove leaked oil according to the procedure for cleaning mineral or synthetic oils.

After an oil leak, it is recommended to drain the motor oil completely and refill the motor with fresh oil. Oil leakage does not limit the functionality of the motor in the short term.

In connection with pressure equalization processes, oil can get into the plug through the strands of the motor cable. This can cause a light film of oil to form on the contacts of the plug. This oil film does not restrict the functionality of the plug.

Always transport and store motors upright.



Correct



Incorrect

Torque support with axle stub or transport lock must be fitted.



Right,
with torque support
and stub axle



Right,
With transport lock



Incorrect

Either the brake disk must be mounted or the threaded holes for the brake disks mounting must be closed with suitable setscrew.

However, this only applies to motors with M8×0.75 thread for brake disks assembly!

For motors with thread M6×0.5, the threaded holes do not have to be closed.

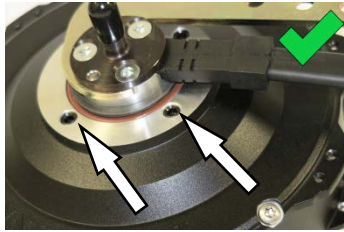

Correct,
with setscrews



Correct,
with brake disk



Incorrect

3 Installation of the drive set

3.1 Installation of the controller box

3.1.1 Fastening the controller box

Each controller box has two screw lugs on its housing for mounting. Only these screw lugs may be used for mounting controller boxes (see fig.).

Screw recommended by HEINZMANN:

Cylinder screw DIN-EN-ISO14580-M5x12-8.8 galZn with Precote[®] 30-8 coating

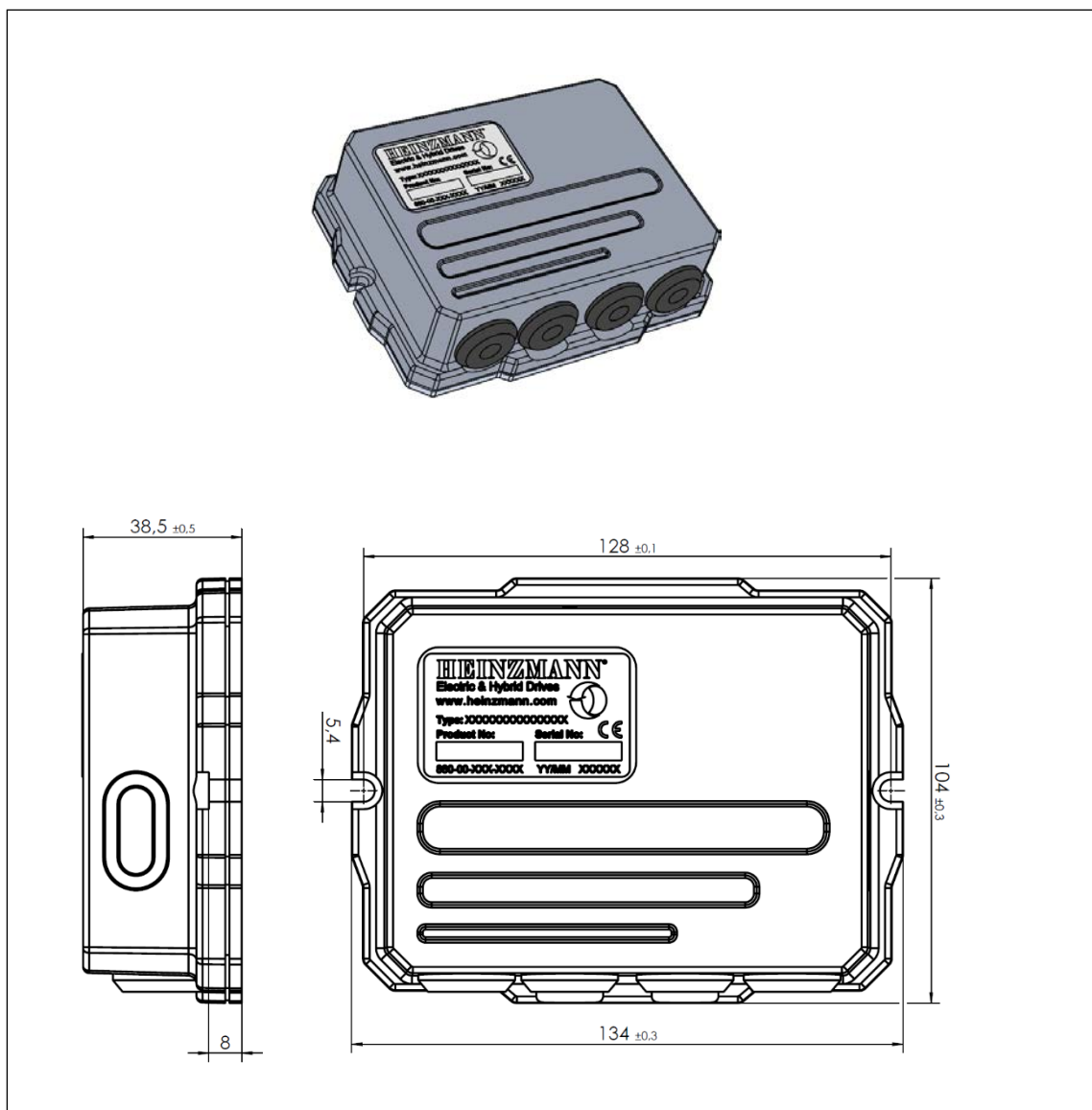
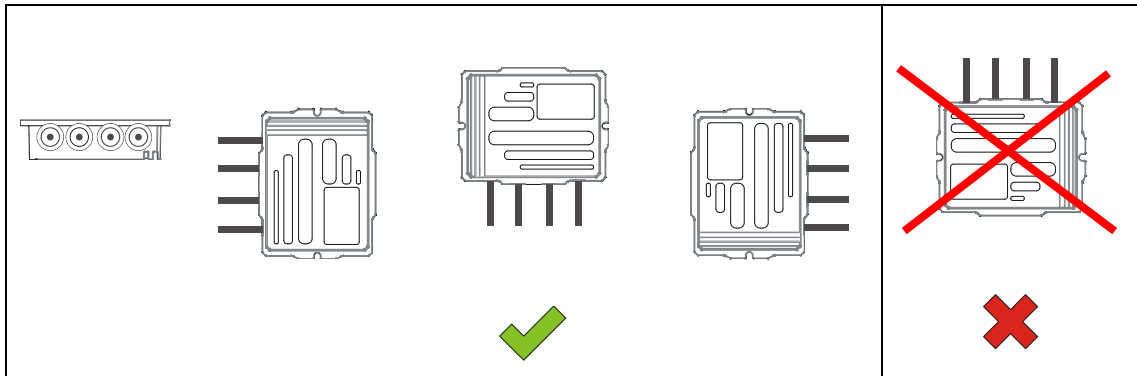

Fig. 5.1 Dimensions of the controller box

3.1.2 Installation location and position of the controller box, cable routing

To increase operational safety, controller boxes should always be mounted in positions that are as well protected as possible from rain or splash water. The controller box must not be permanently exposed to splashing or gushing water. Installation locations such as wheel housings or similar are not suitable.

The horizontal installation position of the controller box is not critical. If the controller box is installed in an upright position, it must be oriented in such a way that the exiting cables do not point upwards, but downwards or sideways.



If possible, do not lead cables coming out of the controller box upwards, but downwards, so that any water flowing along the cables does not flow to the controller box.

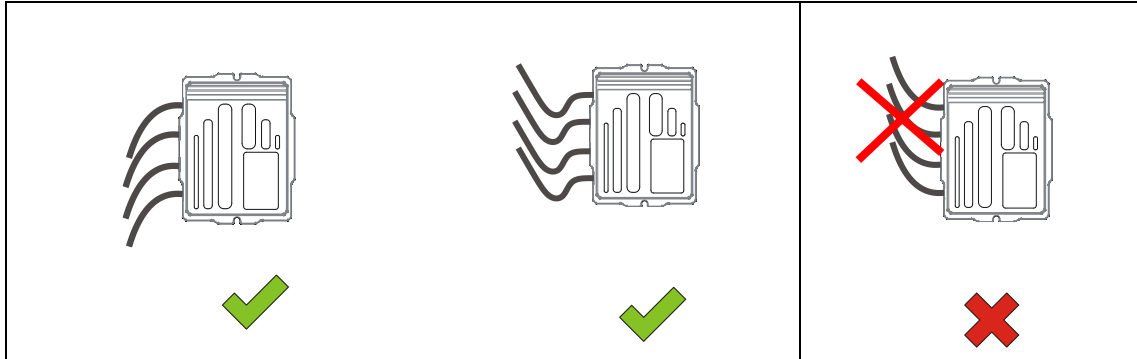

3.2 Installation of the motor

⚠ WARNING	Risk of breakage
	<p>Installation of the drive system in vehicles that are not sufficiently stable can cause load-bearing parts to break during operation! This may result in a fall!</p> <ul style="list-style-type: none"> > Install CargoPower motor RN 111 only in forks and frames, which can withstand use with electric auxiliary drive up to at least 113 Nm!

⚠ CAUTION	Danger due to unforeseen motor activity and rotating parts
	<p>The motor may start moving unexpectedly if the drive system is left on while working on the vehicle. Limbs or clothing may be drawn into rotating parts. This can result in injuries.</p> <ul style="list-style-type: none"> > Remove the battery before any work on the vehicle. > When putting the vehicle back into operation after assembly or repair, position it so that the drive wheel can rotate freely. Only then reinsert the battery and check the proper function of the drive.

NOTICE	<p>The stub axle is only provisionally pre-mounted on the CargoPower motor RN111 at the factory! It must be fastened with suitable axle stub screws from HEINZMANN before installing the motor.</p> <p>(art. no. 001-01-030-21, TORX®).</p> <p>Tightening torque: 8.5 Nm +1.2 Nm</p> <p>Tightening torque of the wheel nuts of the drive wheel during installation:</p> <p>45 Nm ± 5 Nm (for M10×1)</p> <p>for other thread sizes see technical drawing</p>
---------------	---

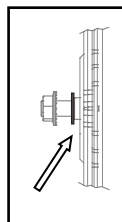

When installing a front wheel motor, a washer must always be mounted on the axle between the motor and the dropout on its A-side!

3.2.2 Motor cable routing

It is mandatory that the cable on the motor is mounted upwards or horizontally. If the cable points downwards, oil can collect in the connector.

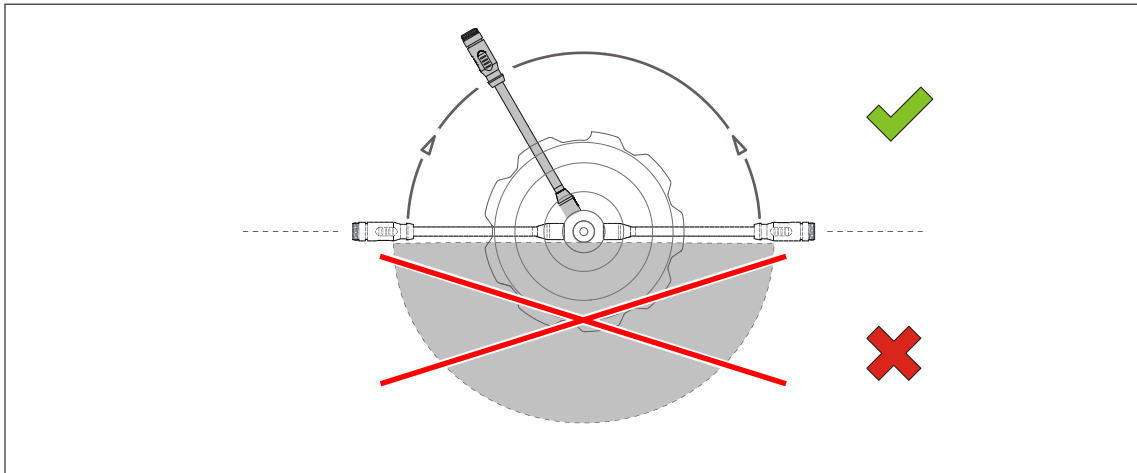

NOTICE



The brake disk screws and the brake disk itself must never rub against the motor cable. The motor cable must be positioned on the frame of the vehicle in such a way that chafing is excluded and securely fasten the cable in this position with cable ties or adhesive tape.

3.2.3 Brake disks

⚠ WARNING	Reduced braking function
	<p>Dirty brake disks lead to reduced braking power or complete failure of the brakes! This can result in a fall!</p> <p>> Always keep brake disks free of oil or lubricants</p>

Suitable for the CargoPower motor RN111 motor are brake disks with the following technical data:

Brake disk diameter:	at least Ø160 mm or larger
Recording:	4-hole Rohloff
Bolt circle:	Ø65 mm
Fastening:	M6×0.5 (HEINZMANN special screw)

NOTICE

The threaded hole for the brake disk fastening screws must not be drilled open or deeper. This can damage the motor housing and there is a risk of oil leaking out.



For the installation of brake disks there is an instruction video from HEINZMANN on the media portal *YouTube*.

It can be accessed at the following address:

- German-language:
<https://www.youtube.com/watch?v=j2QrnWHL07g>





- English-language:
<https://www.youtube.com/watch?v=yXy39HSY3LI>

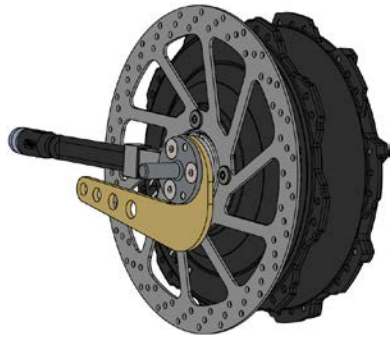

3.2.4 Brake disk initial assembly and change

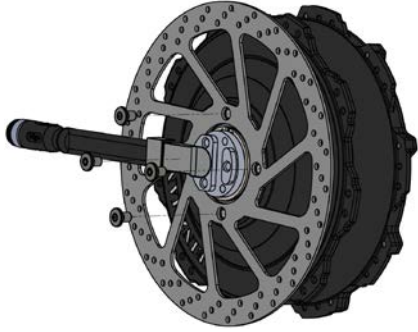
<p>View of the assembled motor Item no.: 880-00-18X-XX</p>	
<p>Disassembly the M6 bolts securing the stub axle.</p> <p>NOTICE Disassembled screws must not be reused for assembly.</p>	
<p>To disassembly the stub axle and torque arm, use an impact puller. Without it, there is a risk of damaging the pin holes during disassembly.</p> <p>An impact extractor is available from HEINZMANN.</p> <p>Item no.: 880-80-303-00</p>	
<p>View of the motor, stub axle and torque arm disassembled.</p>	

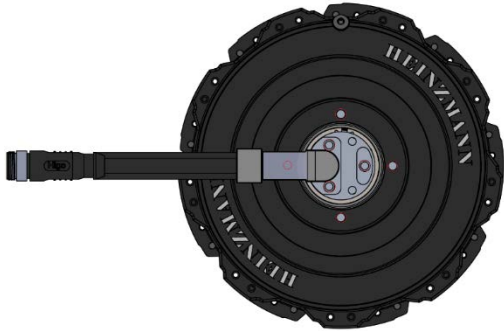
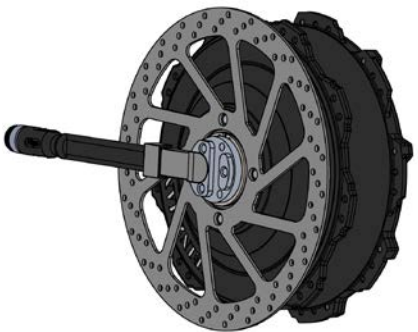
<p>Disassembly of the brake disk bolts.</p> <p>NOTICE Dismantled brake disk bolts must not be reused for assembly.</p>	
<p>Remove the brake disk.</p>	
<p>Before reassembling the brake disk, stub axle and torque arm, all threaded holes must first be carefully cleaned.</p> <p>The threads can be damaged by residual threadlocker when fitting new brake disk bolts.</p>	
<p>View of the motor with repositioned brake disk.</p>	

<p>New brake disk bolts must be coated with Precote® before fitting.</p> <p>Such screws are enclosed with each motor on delivery. Service packs with matching screws can also be obtained from HEINZMANN.</p> <p>Special screw M6×0.5</p> <p>Tightening torque: 10 (+0.5) Nm</p> <p>Item no: 880-80-305-00</p>	
<p>After fitting the brake disk, the torque arm including axle can be refitted.</p> <p>To avoid damaging the pin holes, HEINZMANN also recommends using the impact extractor for assembly.</p>	
<p>The screws for mounting the stub axle must be coated with Precote®.</p> <p>On delivery, 3 screws are included with each motor. Suitable screws can also be obtained from HEINZMANN.</p> <p>Countersunk screw DIN7991 Torx-M6x12-galZn, Precoate® 30-08</p> <p>Tightening torque: 8.5 (+1.2) Nm</p> <p>Item no: 001-01-030-21</p>	
<p>If other bolts are to be used to mount the stub axle, the following specification applies:</p> <p>Screw thread: M6×0,5</p> <p>Screw-in depth: 7.3 mm</p> <p>Strength: 10.9</p> <p>NOTICE Threadlocker is essential</p>	

3.2.5 Sprocket assembly

NOTICE



Mounting a sprocket on the CargoPower motor RN 111 motor instead of a brake disk does not correspond to the intended use and is not permitted without approval by HEINZMANN!

It is essential that such an application is checked in advance by HEINZMANN and that suitable fixing screws are specified for it.

The user should check whether the FREE DRIVE[®] system is suitable as an alternative.

4 Peripherals

Peripheral devices are all additional attachments that are compatible with the CargoPower drive system but are not manufactured by HEINZMANN itself.

The CargoPower drive system can be operated in the following desired modes depending on the application:

- eBike:

The drive system is located in a bicycle for electric assistance while riding, also referred to as a pedelec or EPAC (Electrically power assisted cycle). The CargoPower drive system has been designed in accordance with the standards DIN EN 15194:2018-11 and DIN EN 79010:2020 and can comply with this standard.

- External Control:

The system receives a setpoint value for the torque from a higher-level system via CAN bus and regulates to this.

Depending on the application, the system can consist of the following peripherals:

- Pedal sensor or FREE DRIVE alternator®
- HMI Cargo Remote (human-machine interface)
- Display Cargo View
- Throttle grip or thumb throttle
- Buttons for additional functions (starting aid, reversing, etc.)
- Brake handles with electrical contacts
(cannot be obtained from HEINZMANN)
 - Function: when braking, motor assistance stops
- Accumulator/battery

NOTICE

Only peripheral devices approved by HEINZMANN may be used.

4.1 Pedal sensors



The intended use of the vehicle determines which standard it must comply with (DIN EN 15194:2018-11 or DIN EN 79010:2020).

The vehicle manufacturer must therefore consider whether the type of pedal sensor he has selected is suitable and permissible.

4.1.1 Speed sensor

Speed sensors measure the speed of the pedal crank. The pedal sensor and encoder disk are third-party products. Depending on the configuration of the system, they may come from different manufacturers. It is mandatory that the instructions provided by the respective manufacturer are followed. For special cases, please refer to these documents and instructions. The following installation instructions have proven themselves in practice.

Information on speed sensors can be found under the following links:



http://www.king-meter.com/backend//KingMeter_upload/material/doc/2021-03-02/DH%20Sensor_User%20Manual_V1.0_20210114_1614647018989.pdf

The encoder disk is normally mounted on the chainring side of the bottom bracket shaft. It can be mounted on the right or left side. For mounting, the bicycle must be equipped with a square bottom bracket with a stop collar and sufficient remaining four edge length for the crank arm.

The following minimum dimensions are required:

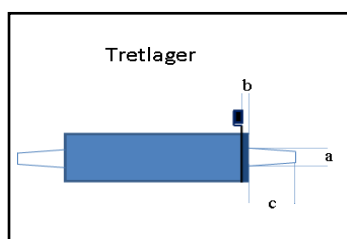

$a > 16 \text{ mm}$

$b < 4 \text{ mm}$

c: must be greater than:

Crank eye width + width of the encoder disk so that the encoder disk can be mounted

- Remove any existing chain guard
- Dismantle chain and crankset
- Screw bottom bracket out of bottom bracket tube with suitable bottom bracket key.
- Remove any chain guards that may be present

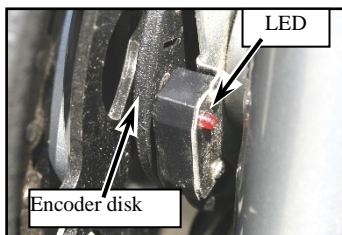
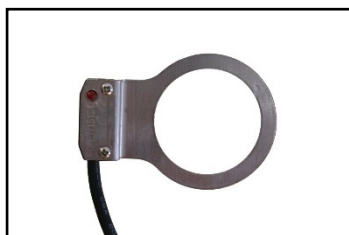

i Pedal sensors are available in two versions, one each for the right or left side of the bottom bracket. Check the position before mounting.

- Push the eyelet of the pedal sensor onto the bottom bracket up to the stop collar. The LED on the sensor must point towards the bicycle frame.
- Slide the chain guard back onto the bottom bracket
- Screw the bottom bracket back into the bottom bracket tube and tighten with the bottom bracket spanner (tightening torque according to manufacturer's instructions).
- Slide the encoder disk onto the bottom bracket shaft

i Observe the direction of rotation of the encoder disk (see arrows on the disk).
The encoder disk must run round and flat after installation. Observe the minimum dimensions of the square length.

- Mount crankset and chain, (tightening torque according to manufacturer's instructions).
- Refit any existing chain guard

4.1.2 Torque sensor

Torque sensors measure the speed and the torque generated at the crank by pedaling. They are not attached to the bottom bracket but are part of the bottom bracket. Torque sensors are available with measurement on one or both sides. HEINZMANN recommends the use of sensors that measure on both sides.

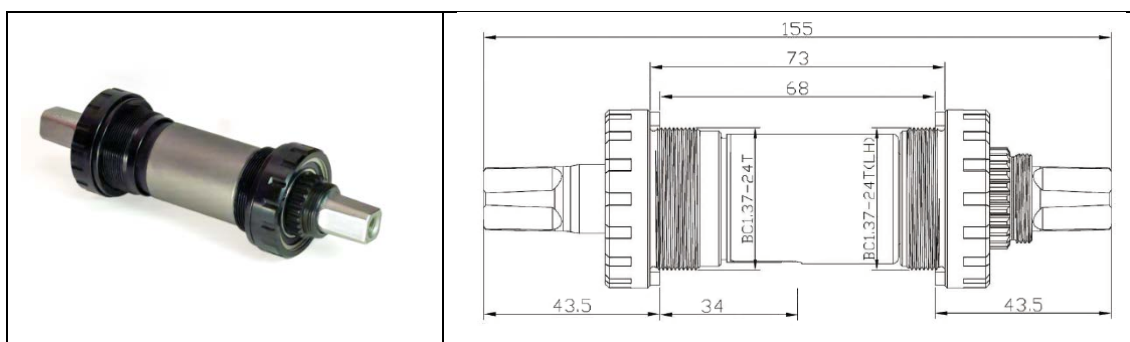

Torque sensors are third-party products. Depending on the composition of the system, they may come from different manufacturers. The instructions issued by these manufacturers, if any, must be observed without restriction.

For more information, see the following links:



Autorq <https://www.autorq.com/dual-sided-torque-sensors>



NCTE <https://ncte.com/e-bikes/#>



Thun <https://thun.de/de/project/x-cell-rt-3-0geeignet-fuer-pedelegs-und-e-bikes/>

In addition to the systems with speed or torque sensors, there is also the FREE DRIVE system[®], which HEINZMANN is developing in cooperation with Schaeffler AG. This system works without chains for mechanical power transmission via and is based on a pedal-driven generator. Details can be found in chapter 5 System FREE DRIVE[®]

4.2 HMI and display

HMI (human-machine interface) and display are third-party products. Depending on the composition of the system, they may come from different manufacturers. If a different HMI or display is used on the vehicle, additional information can be requested from HEINZMANN.

HMI

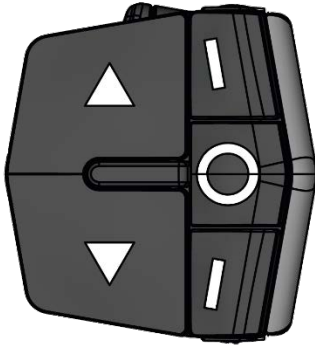
 <p>EOX Remote 500 HMI Cargo Remote</p>	Version	CargoRemote (HMI)
	Item no.	010-69-414-00
	Protection class	IPX7
	Assembly	Bicycle handlebar Ø22.2 mm
	Communication	Bluetooth LE, CAN
	Operating elements	Buttons, light sensor, rear light
	Matching display	CargoView
	Functions	System on/off Support levels Battery charge status System error Light on/off, Light on/off button, Automatic
	Display	LED strip, multicoloured



For a description of the functions of the HMI and its use on the FREE DRIVE system® see chapter:
5.3 Using the HMI

Display

 <p>EOX View 1200 Display Cargo-View</p>	Version	CargoView
	Item no.	010-69-414-01
	Protection class	IPX7
	Assembly	Centre bicycle handlebar Ø31.8 mm
	Connection	Cable switch
	Operation	Via CargoRemote (HMI)
	Functions	Speed
		Range (km)
		Mileage
		Error messages
		Status light
	Display	FSTN, transreflective

When using HMI and displays the current instructions of SIGMA-ELEKTRO GmbH must be observed.

For more information, see the following links:



<https://sigmasport-ebike.com/integrated#rubrik-ebike-2>



<https://www.sigmasport.com/de/haendler/downloads>



For safety, the starting aid is not activated via the Cargo Remote HMI, but with a separate button.

See chapter 4.4 "Buttons for further functions".

4.3 Throttle grip and thumb throttle

Throttle grip and thumb throttle are third-party products. These can be used on pedelecs for starting driving assistance or on scooters for torque setting. For information on how to use the start-up aid, see chapter 4.4 - Buttons for further functions.

More detailed information on the products can be found under the following links:



Catalogue <https://www.star-union.net/products-catalog/>



Thumb gas <https://www.star-union.net/e-bike-130x-product/>



Throttle grip <https://www.star-union.net/e-bike-192xht375-product/>

Thumb throttle

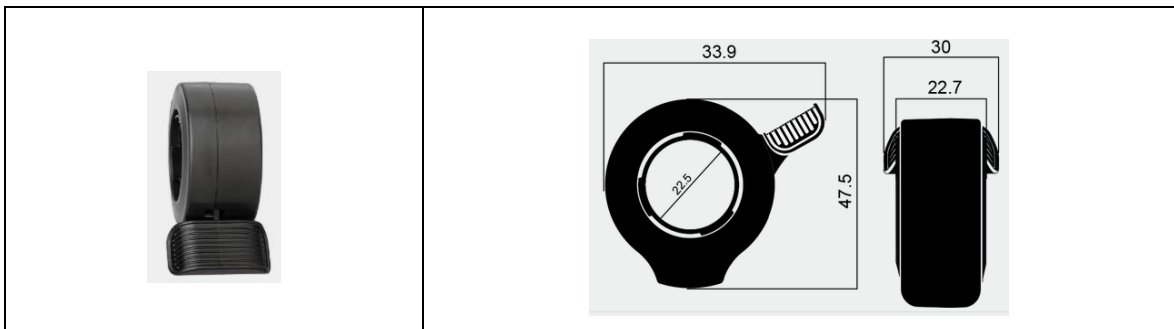

Throttle grip

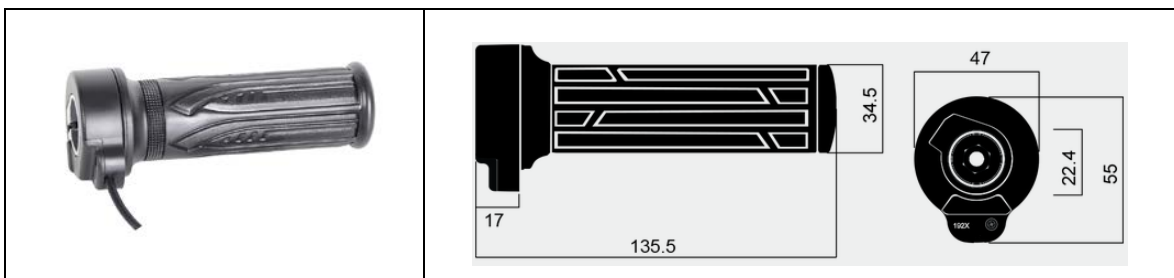

4.4 Buttons for further functions

The following functions can be used by fitting additional buttons:

- Starting aid
- Reverse

For these functions, the buttons used are identical in construction. To avoid confusion, the plugs of both buttons are different depending on the function:

- Starting aid > Male plug
- Reverse > Female plug

4.4.1 Button for starting aid or reversing:

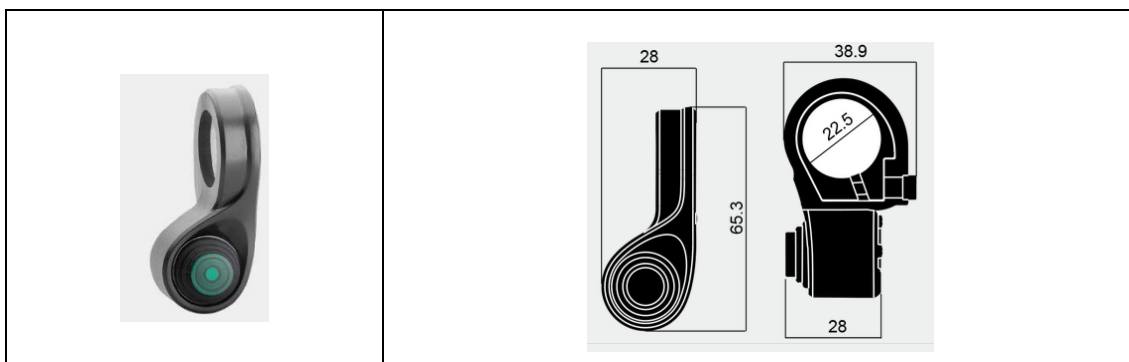

4.4.2 Starting aid function:

The starting aid may support up to 6 km/h (DIN EN 15194:2018-11) without having to pedal.

There are two ways to activate the starting aid when the vehicle is stationary:

- With knob and throttle/thumb throttle:
Press the button for starting aid and at the same time press the thumb throttle/throttle grip. This activates the starting aid.
- With brake contact and throttle/thumb throttle:
Pull the brake handle and at the same time press the thumb throttle/throttle grip. If the brake is now released, the starting aid is activated.

4.4.3 Reverse function:

- With reverse button and throttle grip/thumb throttle:
Press the button for reverse and at the same time twist the grip throttle respectively press the thumb throttle. This will activate the reverse drive.

4.5 Batteries

It is possible to use the CargoPower drive system with a single as well as with several batteries. Batteries are not part of the HEINZMANN delivery scope. The following list provides an overview of the Batteries from other manufacturers that can be used:

F 20 001 - d-e *"List of suitable Batteries for the operation of
CargoPower - Drive System for Light Electric Vehicles".*

This is available via the download area of the HEINZMANN website:



<https://www.heinzmann-electric-motors.com/downloads/cargo-power-system>

The use of power sources other than those listed may be possible. Prior approval must be obtained from HEINZMANN.

NOTICE

In any case, the operating instructions and technical information of the respective battery manufacturer must be strictly observed!

Basically, a distinction is made between two groups of usable rechargeable batteries:

- Batteries without communication
- Batteries with CAN communication

4.5.1 Batteries without communication

Such batteries usually become active immediately after insertion and immediately supply energy to the CargoPower drive system (controls are switched on instantly).

This results in the following:

- It is not possible to switch the CargoPower drive system on or off using a control element on the handlebar.
The system is only switched on or off by inserting or removing the battery, unless otherwise provided for by a circuit of the vehicle manufacturer. It is essential to follow the instructions of the vehicle manufacturer.
- The state of charge of the battery can only be estimated from the battery voltage and the characteristic discharge curve of the battery.
- Not all functions of the CargoPower drive system are usable (e.g. recuperation, FREE DRIVE system[®] etc.)

4.5.2 Batteries with CAN communication

Batteries with CAN communication have a battery management system (BMS). This controls and monitors the charging and discharging processes of the battery in order to use it as efficiently as possible. The BMS can provide the user/controller with a lot of useful information.

This results in the following:

- If only one battery is used, it can be switched on and off via the control element, but not all batteries support this function
- Through the CAN connection, the battery charge level determined by the BMS can be accessed

4.6 Wiring and connections

4.6.1 Notes on EMC

- In DIN EN 15194:2018-11 two different measuring distances of 10 m or 3 m are provided for measuring EMC. The permissible limit values differ for both measuring distances. Experience shows that the results of the measurement for a distance of 3 m are more advantageous.
- It is advantageous for EMC if all cable lengths are kept as short as necessary. Excessively long cables or loops increase the risk of interference.
- Cables should not be laid in parallel if possible. Above all, motor and battery cables must be routed as separately as possible from each other and absolutely separately from signal cables in the vehicle.
- If problems occur during EMC testing, folding ferrites on the cables can usually remedy the situation. By using them, it can be determined which cables are the cause of the problems. Additional shielding or modified routing solves the problems in most cases.
- In order to improve EMC, it has proven useful to choose an installation location for the controller box that is as low as possible on the vehicle.

4.6.2 CargoPower System

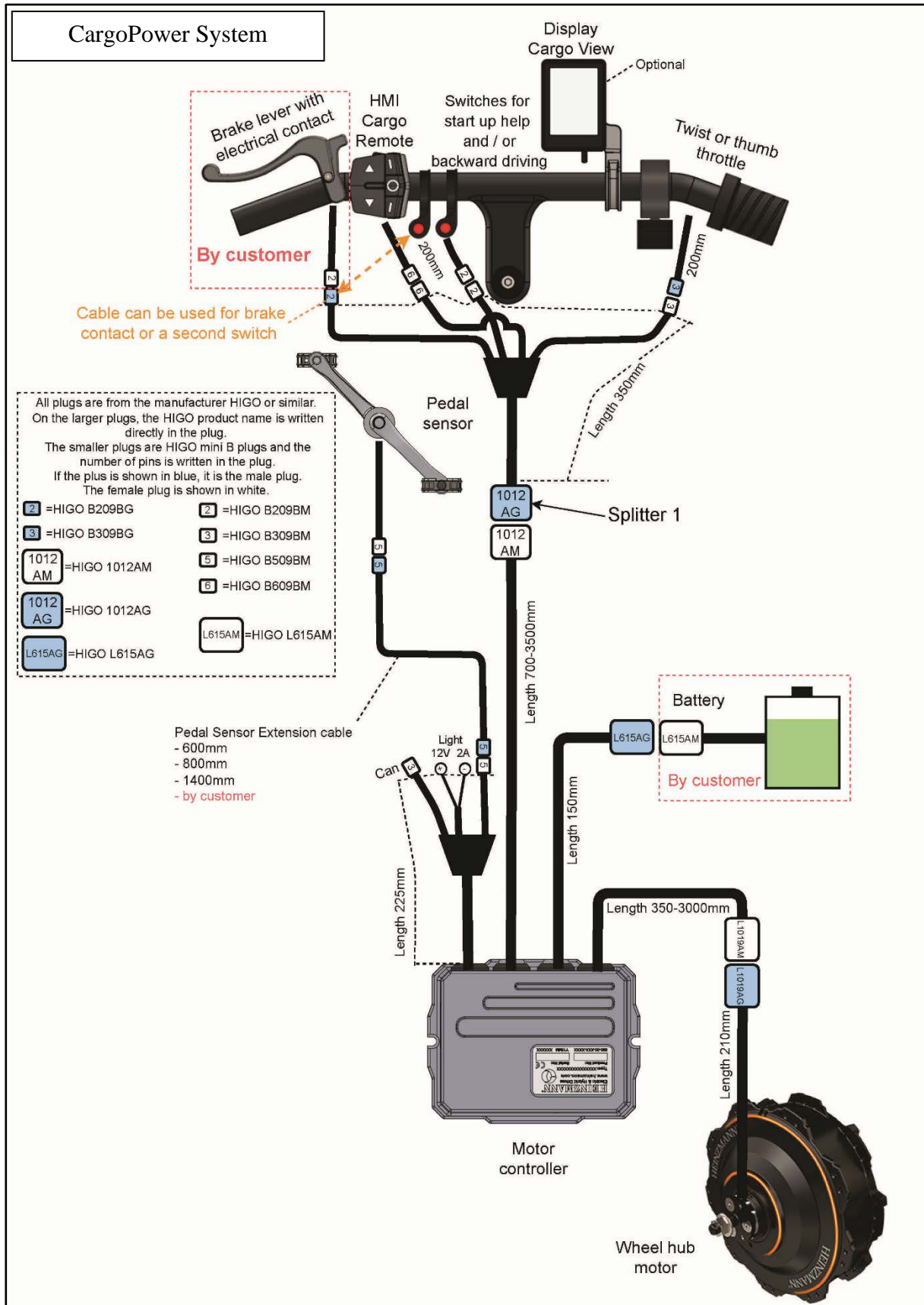

4.6.3 CargoTwinPower System

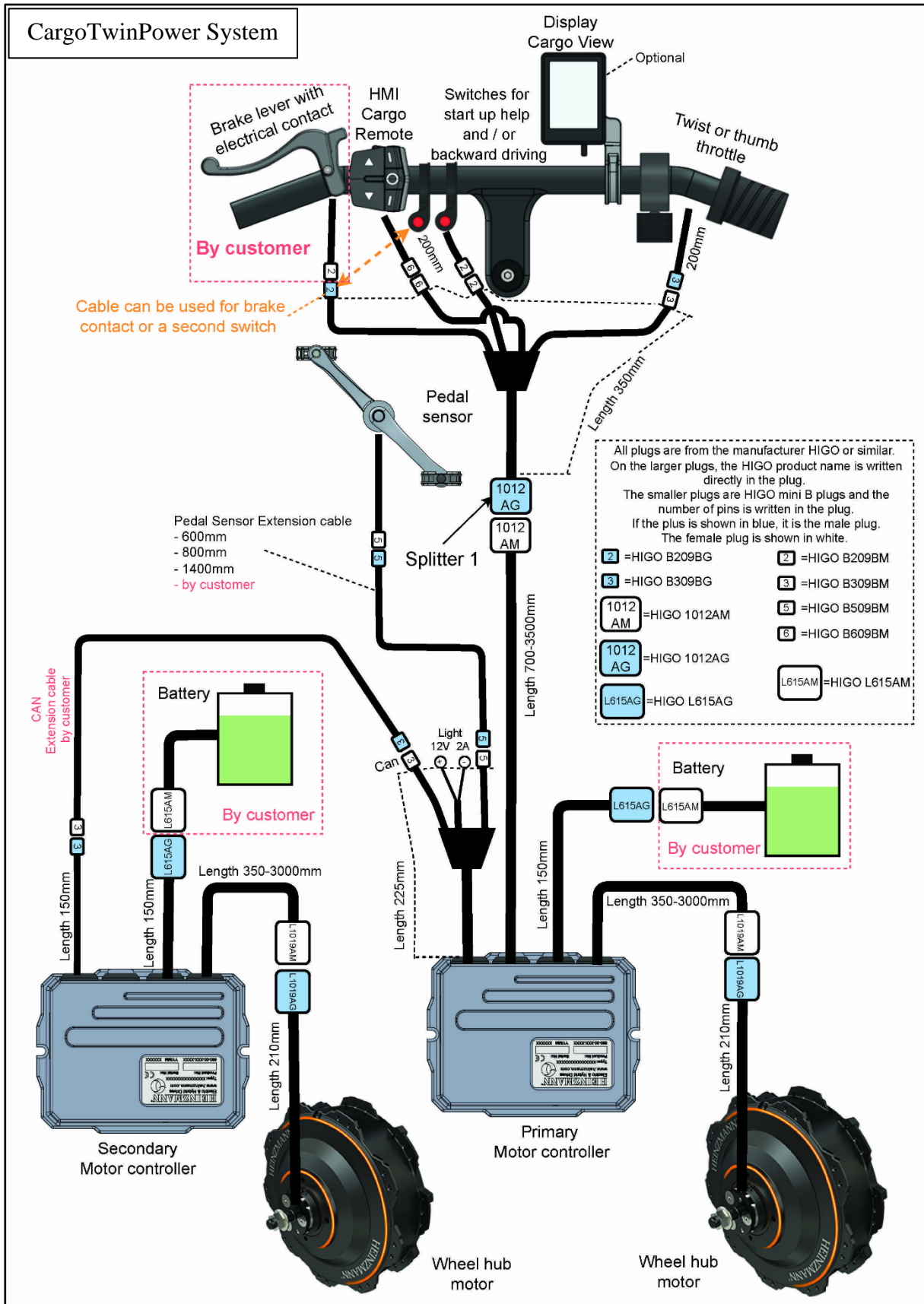

4.6.4 CargoTwinPower system with one battery

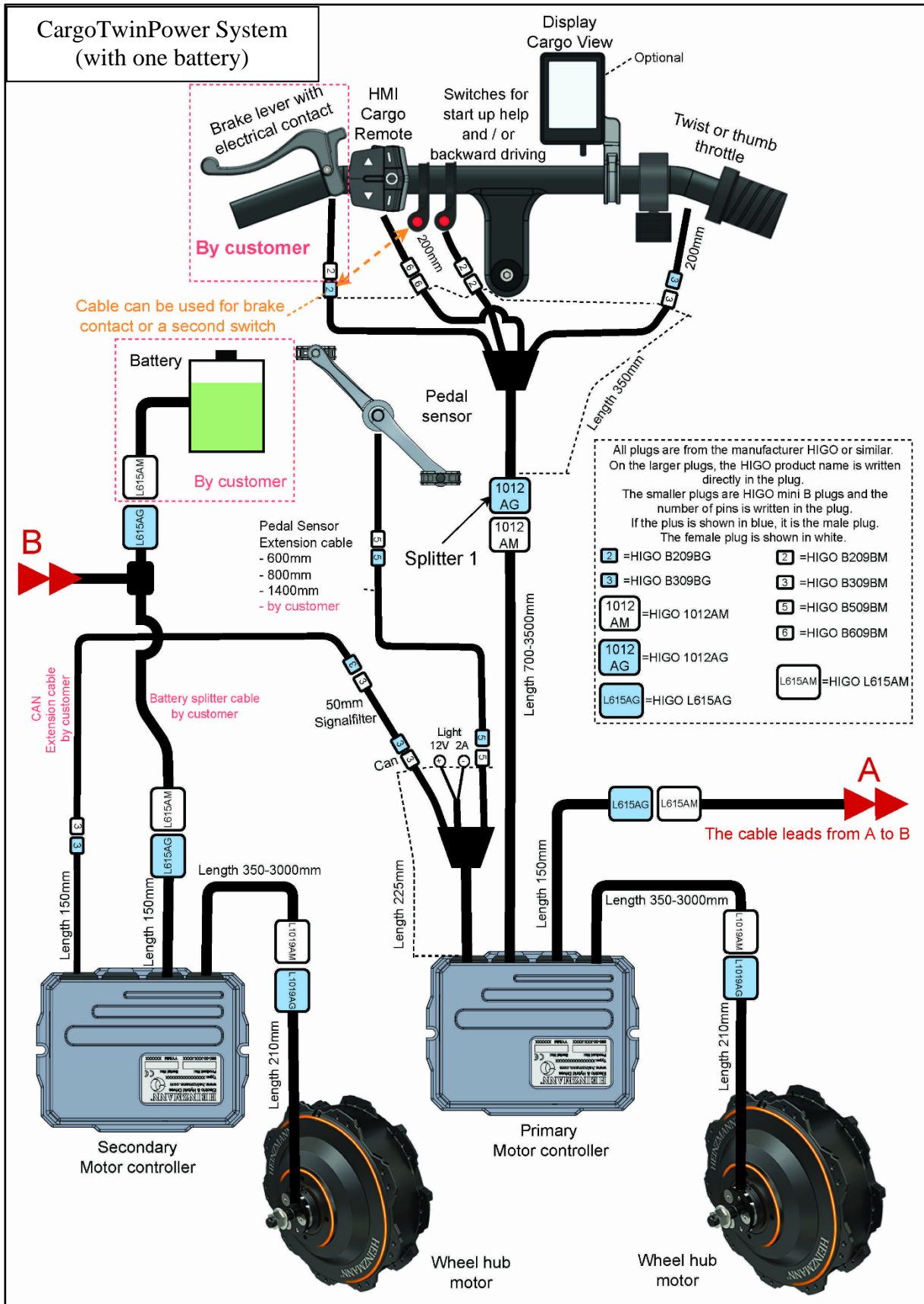

5 System FREE DRIVE®

The FREE DRIVE system® was developed in cooperation between the companies Heinzmann GmbH & Co KG and Schaeffler AG.

An elementary feature of the system is that it no longer has a mechanical chain. Instead of a conventional chain transmission, a generator is installed. This simulates a pedaling feeling and feeds the electrical energy generated by pedaling into the drive system. It also replaces a torque sensor.

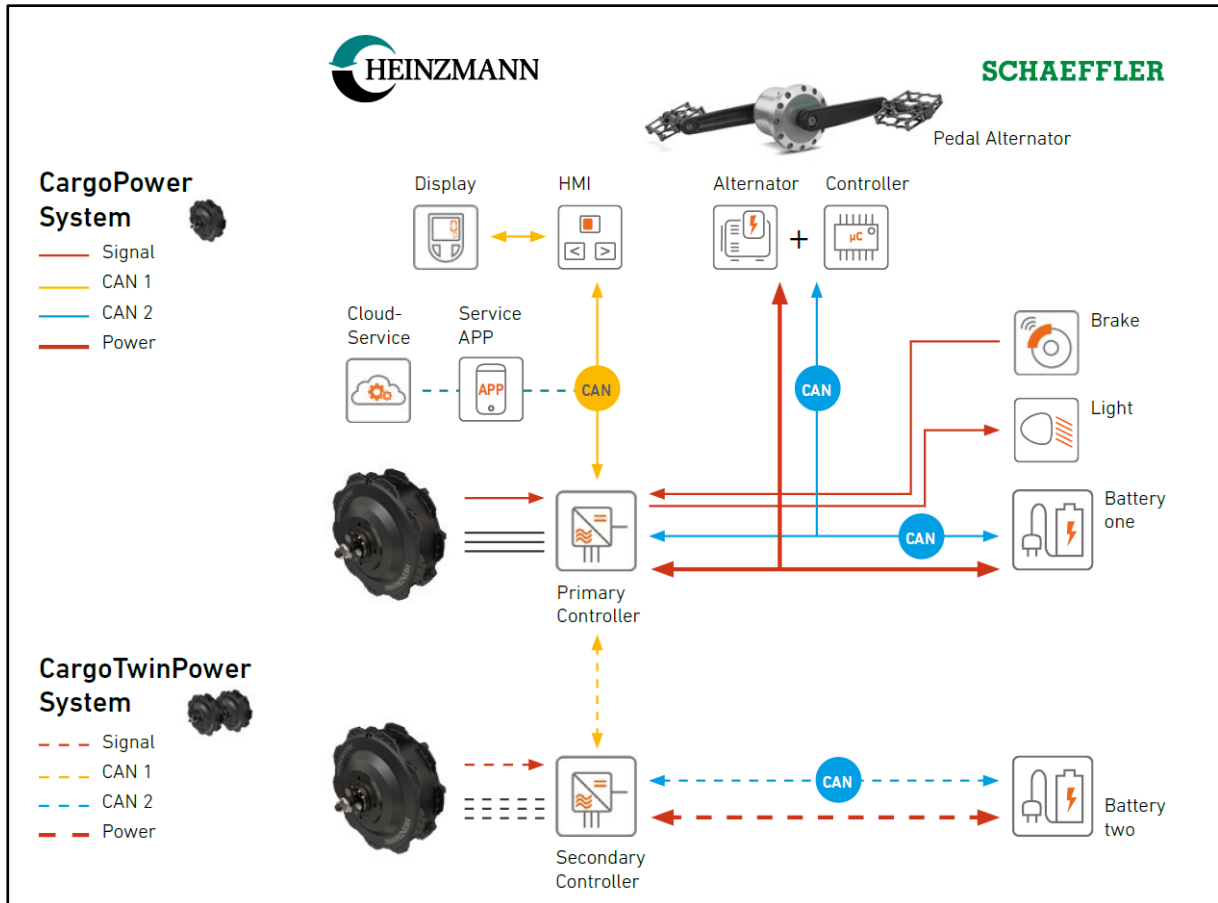

Scheme System FREE DRIVE® -



Proper operation of the FREE DRIVE® system requires the following:

- Batteries must have a battery management system (BMS)
- A 12 VDC power supply must be permanently available

5.1.1 CargoPower FREE DRIVE® System

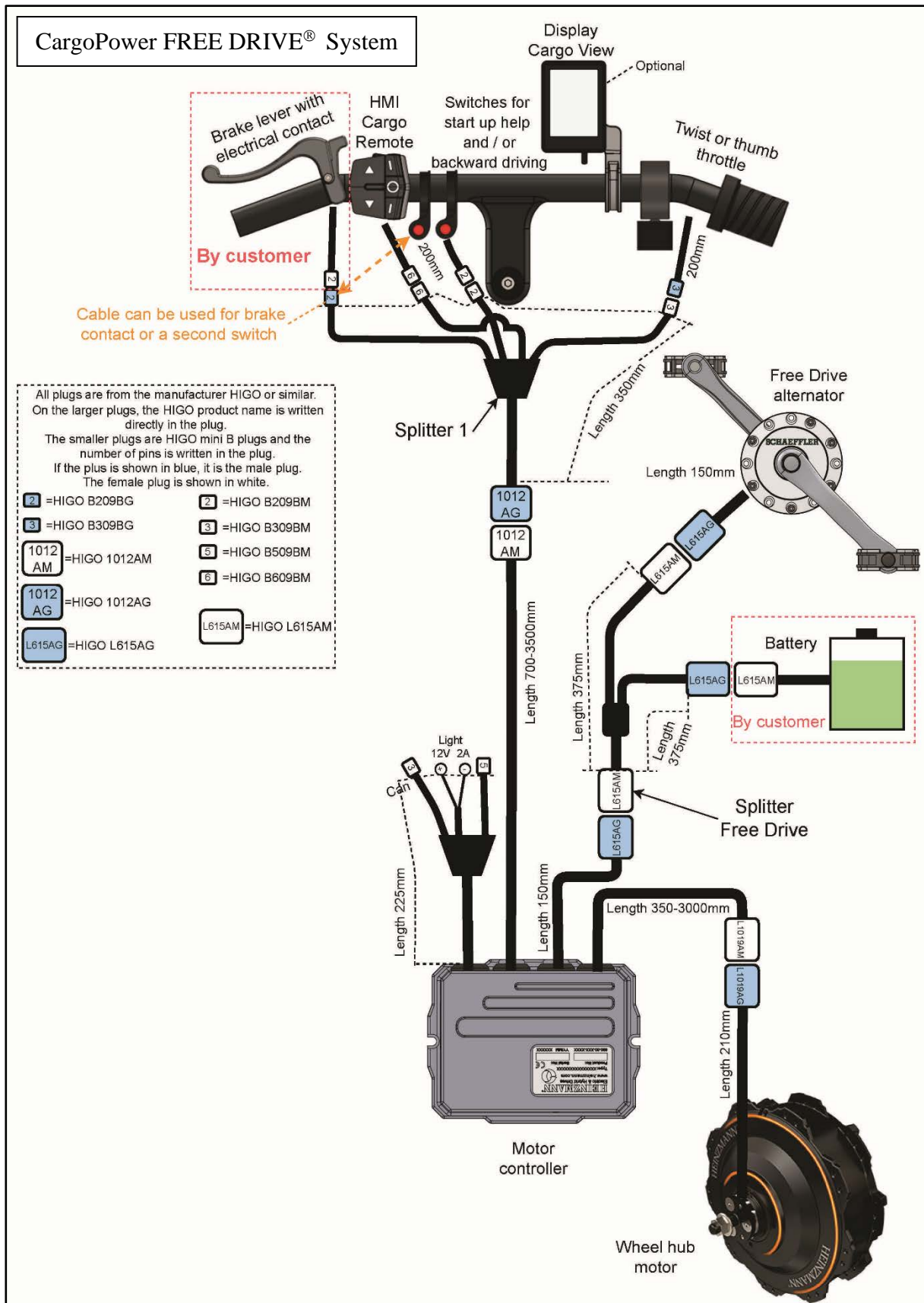

5.2 Installation of the FREE DRIVE® alternator

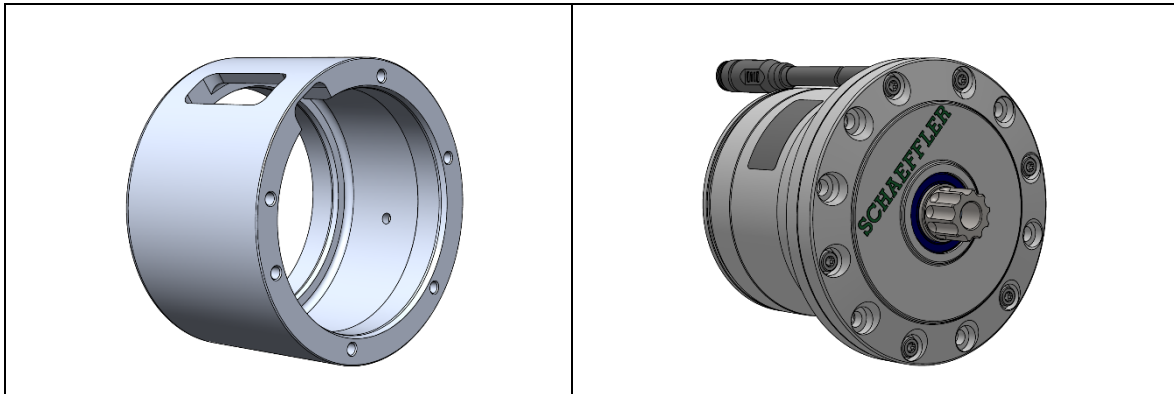

For the installation of the generator a constructive preparation of the vehicle is required. Instead of a normal bottom bracket, a corresponding receptacle with dimensions suitable for the generator must have been integrated into the vehicle frame. A technical drawing with all necessary dimensions of this mount is available from HEINZMANN. The alternator is inserted into the mount and fastened with the corresponding mounting screws.

NOTICE



The mounting screws must be provided with threadlocking (recommendation: Loctite® 243).

Tightening torque of the mounting screws: **8.5+1.2 Nm**

The cable outlet of the generator must point upwards. The most favorable orientation of the generator is the one in which the lettering "SCHAEFFLER" is aligned as horizontally as possible.

5.3 Using the HMI Cargo Remote

This chapter describes the functions of the HMI Cargo Remote.

Safety instructions, instructions for product care, disposal or the CE declaration can be found in the associated SIGMA SPORT EOX 500 manual from the manufacturer.

The following explanations refer to HMI Cargo Remote mounted on the left side of the handlebar. When mounted on the right side, Power On/Off and Light On/Off are reversed.

5.3.1 Key assignment

<p>EOX Remote 500 HMI Cargo Remote</p>	<ul style="list-style-type: none"> ▲ Increase the support level ▼ Decrease the support level A Shift up a gear (manual) / Increase cadence (CVT mode) B Switching the display C Short press: Shift down a gear (manual) / Reduce cadence (CVT mode) Long press: Shift: Manual gearbox/CVT LED Illuminated display bar
<p>Power button</p>	<ul style="list-style-type: none"> ⏻ Power button On/Off
<p>Light button</p>	<ul style="list-style-type: none"> ☹ Light button • Short press: switch on / off • Long press: automatic mode

5.3.2 System Start

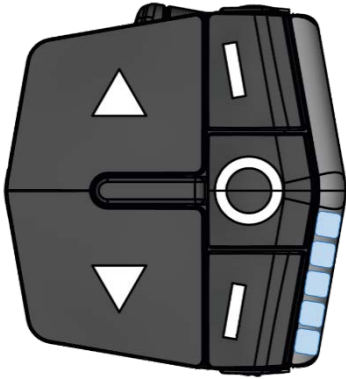







- Press and hold the power button for ≥ 4 seconds to start the system.
- The lower display bar starts to light up blue and shows the current charge status of the battery.
- System start is complete, the system is in standby mode:
Support level 0 = ", Zero"
For system FREE DRIVE
Support level 0 = "Zero", Gear = 0

5.3.3 Support levels

Use the ▲ and ▼ keys to select the desired support level.

Five support levels are available and are indicated on the display bar with the upper LEDs:

					
0 - "ZERO	1 - "ECO	2 - "NORMAL	3 - "HIGH	4 - "POWER	5 - "ULTRA

5.3.4 Battery charge level indicator

The charging status of the battery is shown on the display bar with the lower LEDs.

	Number LEDs		
	5	=	100 %
	4	=	80 %
	3	=	60%
	2	=	40 %
	1	=	20 %

5.3.5 Gear selection and transmission ratio



The maximum number of possible gears (= transmission ratio) of the system is 10. This number is configured by HEINZMANN.

- Briefly pressing button A = Shift up gear
- Briefly pressing button C = Shift down gear

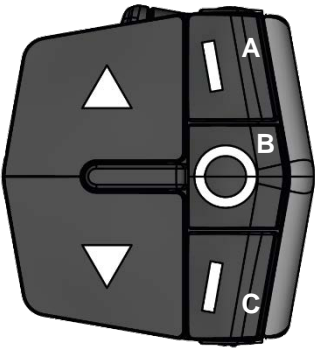

After switching on, the system always assumes the following state:

- Gear = 0
- Support level = "Zero".

	<p>After briefly pressing button A or C, the number of LEDs corresponding to the gear number lights up on the display bar for 1 second.</p> <p>Afterwards, the support level and battery charge status are displayed again.</p> <p> If you shift down to gear = 0, the display bar remains dark for 1 second. After that, the support level and battery charge status are displayed.</p>
--	---

<p>⚠ CAUTION</p> 	<p>Unexpected behaviour of the vehicle</p> <p>The vehicle can accelerate strongly and unexpectedly!</p> <p>Gear = 0 does not mean that the transmission ratio is basically = 0!</p> <ul style="list-style-type: none"> > Before the first drive, check for safety reasons whether a transmission ratio = 0 has been parameterised accordingly. > If no gear ratio = 0 has been set, it is imperative that the driver is informed that the vehicle can start even if the gear ratio = 0 has been set.
---	--

5.3.6 Change between CVT and manual transmission

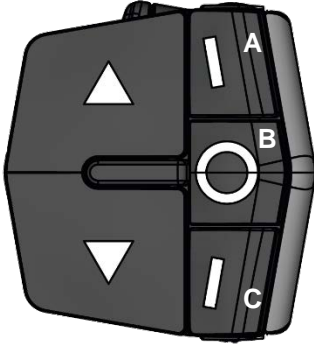
	<p>Switching between manual transmission and CVT gearbox:</p> <ul style="list-style-type: none"> • Press and hold button C ≥ 4 seconds • When the CVT mode is activated, all nine LEDs of the display bar now light up 2\times. The support level and battery charge status are then displayed. <p>i After activation of the CVT mode, the starting cadence is always 50 rpm.</p> <p>Changing the target cadence:</p> <ul style="list-style-type: none"> • Button A = increase cadence • Key C = decrease cadence <p>The adjustable target cadence is adjusted in steps of 5 rpm each. Each of the nine LEDs in the display bar corresponds to such a step.</p> <p>Setting range of the target cadence: 40 ... 80 rpm</p> <table style="margin-left: auto; margin-right: auto; border: none;"> <thead> <tr> <th style="text-align: left;">Number LEDs</th> <th style="text-align: center;">=</th> <th style="text-align: right;">Cadence</th> </tr> </thead> <tbody> <tr><td>9</td><td style="text-align: center;">=</td><td style="text-align: right;">80</td></tr> <tr><td>8</td><td style="text-align: center;">=</td><td style="text-align: right;">75</td></tr> <tr><td>7</td><td style="text-align: center;">=</td><td style="text-align: right;">70</td></tr> <tr><td>6</td><td style="text-align: center;">=</td><td style="text-align: right;">65</td></tr> <tr><td>5</td><td style="text-align: center;">=</td><td style="text-align: right;">60</td></tr> <tr><td>4</td><td style="text-align: center;">=</td><td style="text-align: right;">55</td></tr> <tr><td>3</td><td style="text-align: center;">=</td><td style="text-align: right;">50</td></tr> <tr><td>2</td><td style="text-align: center;">=</td><td style="text-align: right;">45</td></tr> <tr><td>1</td><td style="text-align: center;">=</td><td style="text-align: right;">40</td></tr> </tbody> </table>	Number LEDs	=	Cadence	9	=	80	8	=	75	7	=	70	6	=	65	5	=	60	4	=	55	3	=	50	2	=	45	1	=	40
Number LEDs	=	Cadence																													
9	=	80																													
8	=	75																													
7	=	70																													
6	=	65																													
5	=	60																													
4	=	55																													
3	=	50																													
2	=	45																													
1	=	40																													

6 System settings and service software

Before a CargoPower drive system can be used in driving operation for the first time, it must be fundamentally parameterised and set. This is done with the help of the HEINZMANN service software.

6.1 Configuration Suite

The HEINZMANN E-Bike Service Software is called Configuration Suite and can be downloaded from the following link:



<https://www.heinzmann-electric-motors.com/downloads/heinzmann-configuration-suite>

6.1.1 Installation of the Configuration Suite

- Install Configuration Suite on the computer by executing the "*setup.exe*". Follow the instructions of the installation programme.

6.1.2 Driver installation

NOTICE

Danger of damage due to potential differences!

The electrical connection of the control unit to the computer can cause damage to both if potential differences exist.

Always connect computer and control unit galvanically separated, e.g. with a USB or CAN isolator.

- It may be necessary to install the drivers of the isolator used during initial commissioning.

6.1.3 Starting and setting up the Configuration Suite

With the help of the HEINZMANN Configuration Suite, dashboards can be opened. In the dashboard, current data of the CargoPower system can be read out and certain parameters can be adjusted.

The dashboard file is created customer-specific by HEINZMANN and sent to the customer.

- Save the dashboard file (extension *.dsh*) locally on the computer.
- Start programme "*HZM Configuration Suite*"
- Select "*Add*" and navigate to the location of the dashboard file.

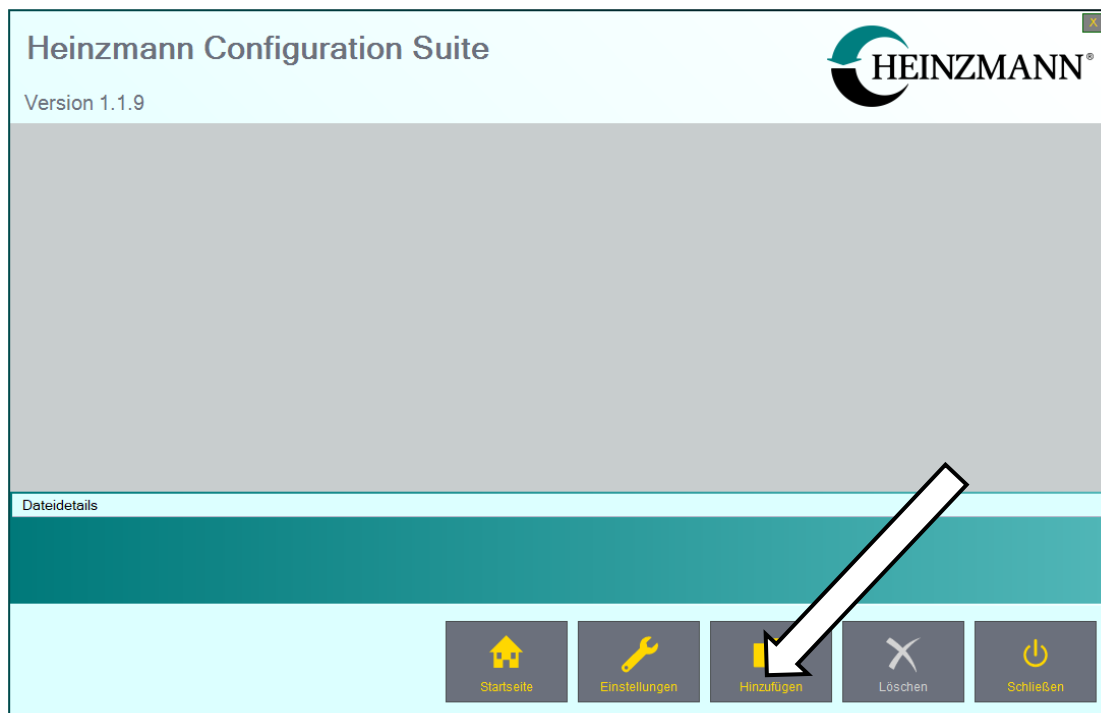

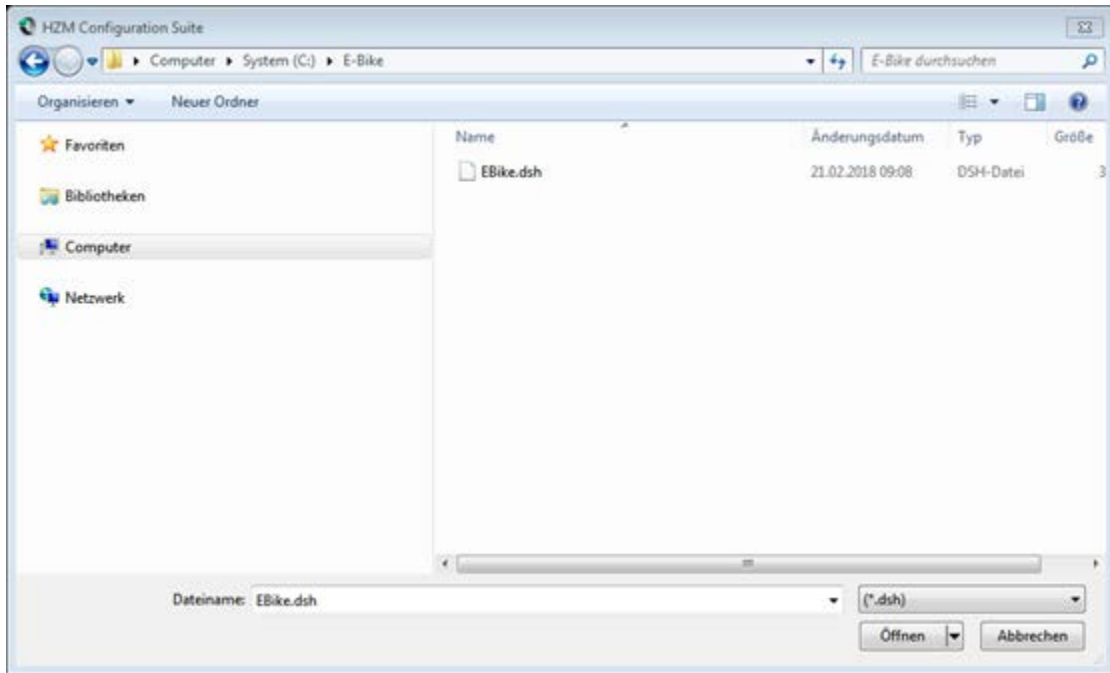

- Then start Dashboard by double-clicking on the corresponding icon

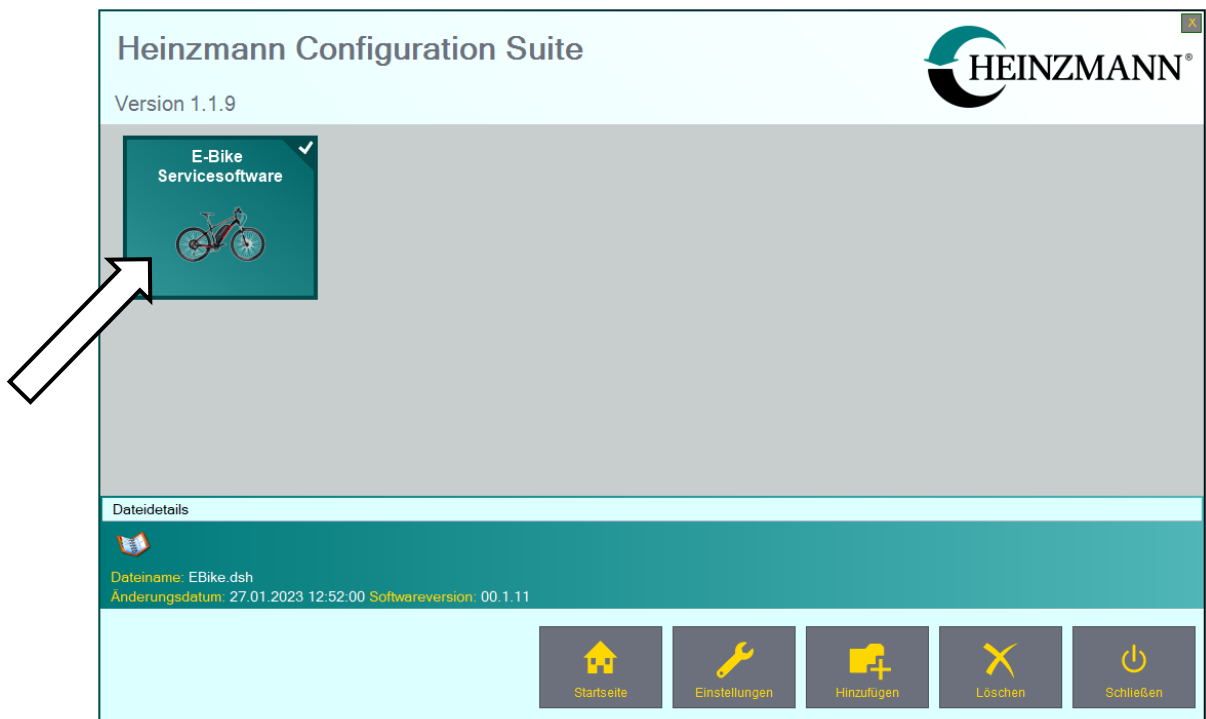

- A window opens with the following interface

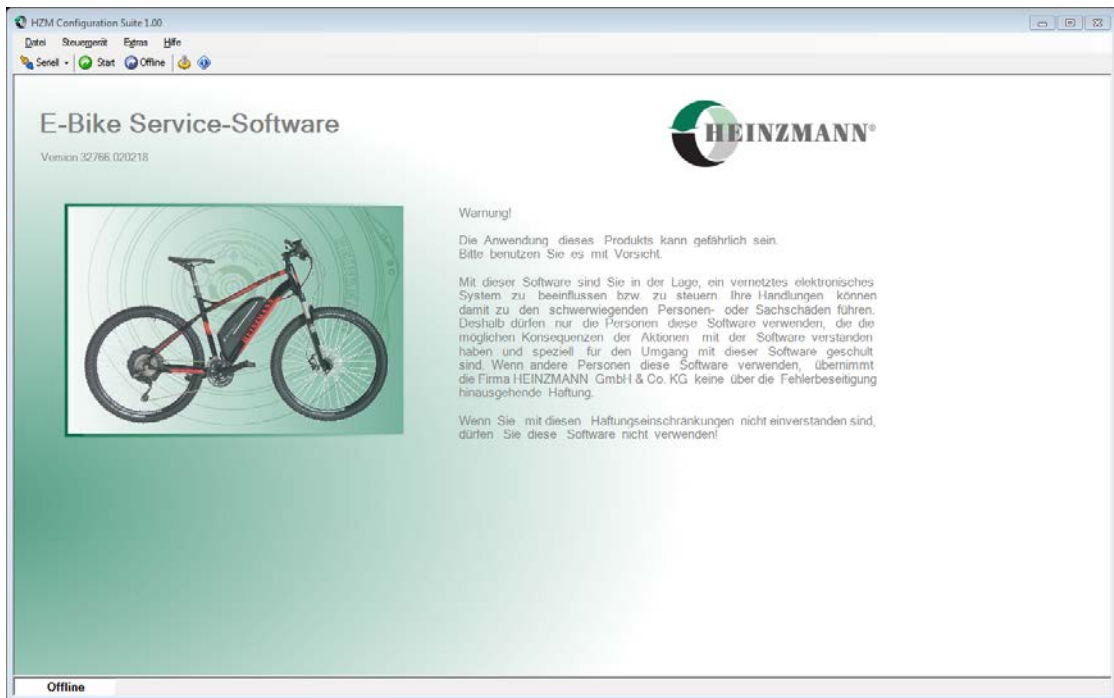

Dashboard Files are backwards compatible. With a dashboard of version 1.12, for example, the software of version 1.10 can be used.

However, dashboard files are not upward compatible. With a version 1.10 dashboard, for example, the version 1.12 software cannot be used.

Always use the latest Dashboard version!

6.1.4 Establish communication

Before any adjustments can be made to the system, a communication link to the control unit must first be established. A charged battery and a fully wired system must be used for this.

NOTICE



Serial connection via USB

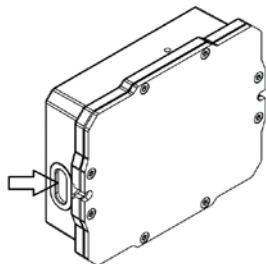

There is a micro-USB socket on one of the short sides of the controller box. This is closed with a rubber plug that must be carefully removed before parameterisation.

To avoid damage USB plugs must be carefully and gently inserted into the socket or removed again!

When the interface is not in use, the socket must always be closed and sealed with the associated rubber plug.

The rubber plug must never be punctured! If a plug is damaged, always replace it immediately with a good one!

- Connect computer and control unit via a USB cable or the separate CAN interface (see Technical Customer Information F23 001).
- Select the correct connection type in the menu ribbon (serial or CAN).

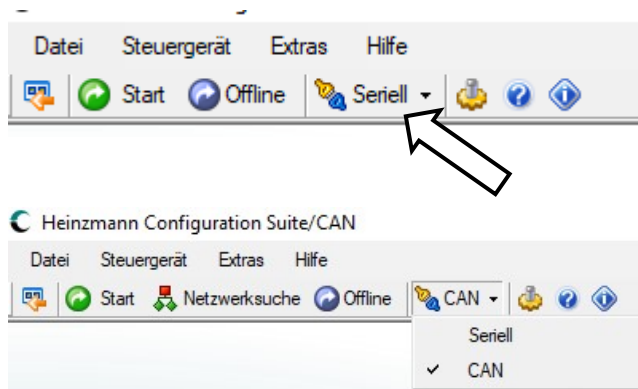

- Click on "**Start**" in the menu bar

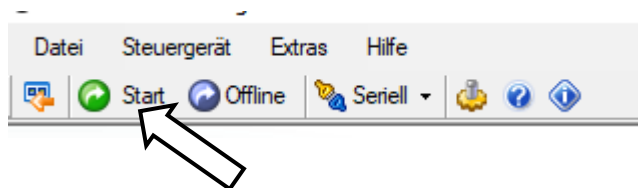

- Confirm the query after searching for a control unit. If further queries are made to establish communication, confirm these as well.
- The green highlighted display "**Online**" in the lower left corner of the window indicates the successful establishment of communication.



NOTICE



CAN connection

HEINZMANN recommends the connection via CAN described below as this has advantages compared to a serial connection.

The access is located between the splitter 1 and the HMI interface, which is located in the cockpit or on the handlebars of the vehicle.

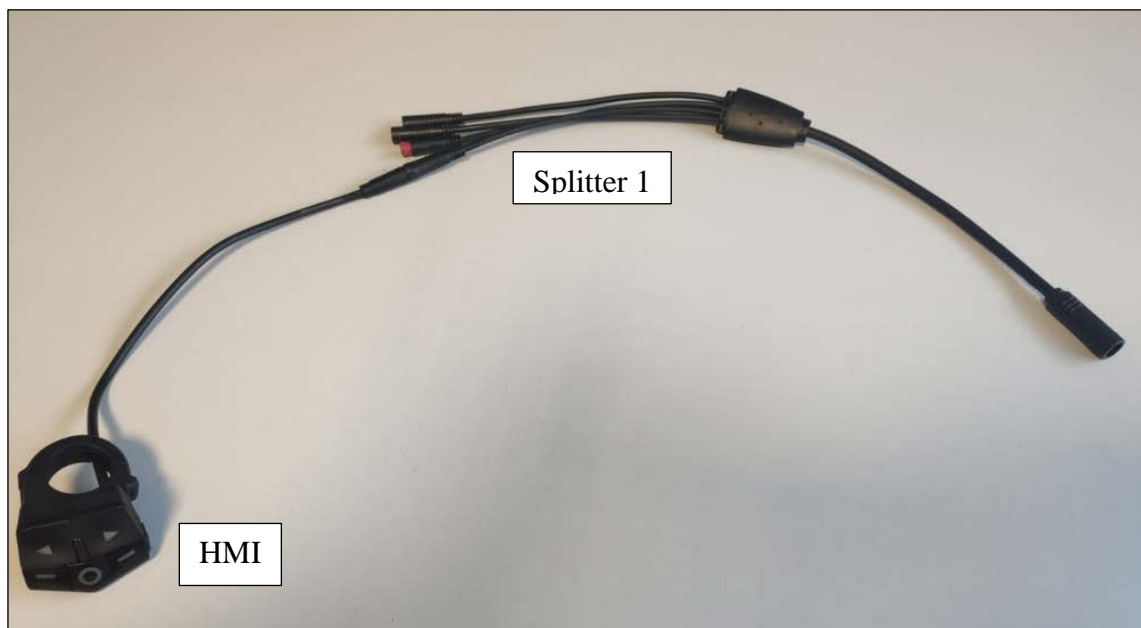

A CAN-Y cable must be installed between splitter 1 and the HMI. This is available from HEINZMANN under item no. 010-00-711-00.



There is an RS 232 connection on the CAN-Y cable to which a CAN interface for USB is connected:

Source of supply e.g.: <https://www.peak-system.com/PCAN-USB.199.0.html>

(recommended is: PCAN-USB opto-decoupled)



The wiring harness for the CAN access then looks like this:



The USB plug on the CAN interface for USB is connected to the port on the PC.

If the connection to the system is now established via CAN as described before, all controllers installed in the system can be accessed.

Advantages of this type of connection are:

- the CAN connection is less susceptible to interference and usually easier to install
- several controllers can be accessed with this connection

Via the serial connection, only the currently connected control unit can be accessed.

6.1.5 Structure of the development dashboard

The dashboard contains the following components:

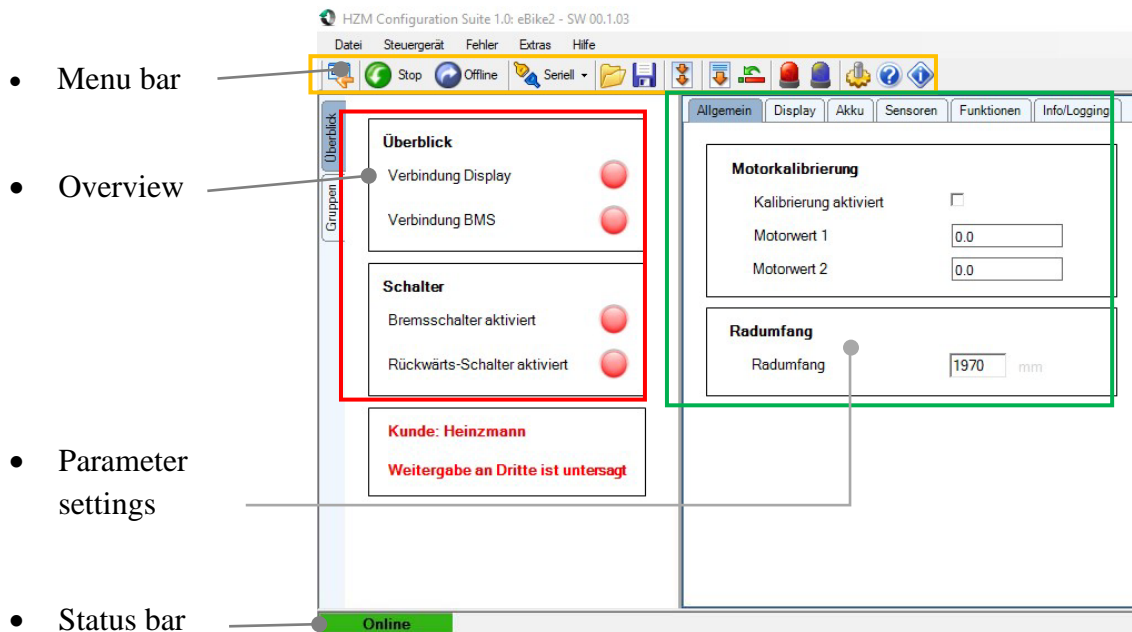

For service calls, there is a dashboard with restricted functions to prevent manipulation by the service partner. This looks like this:

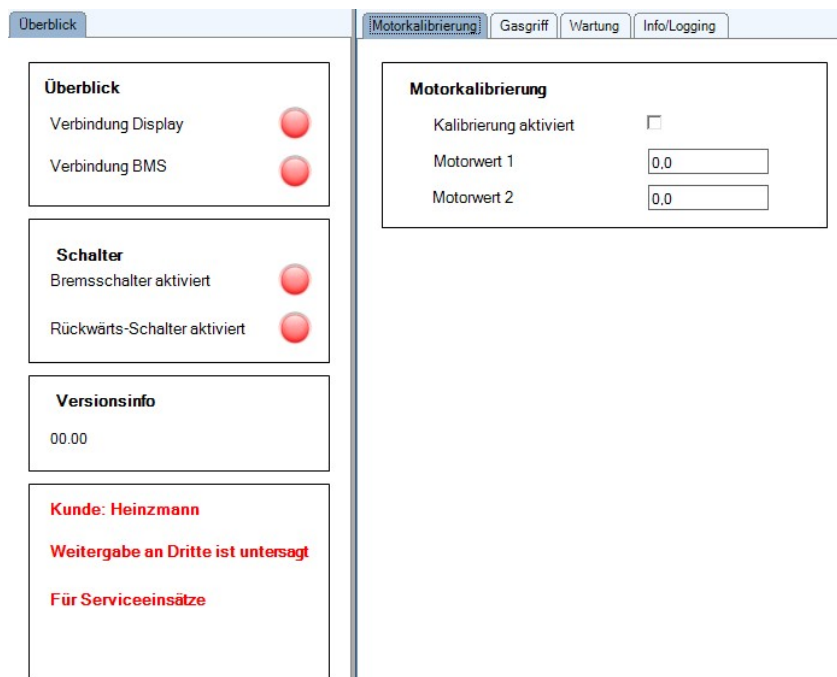

All further descriptions in this manual refer to the development dashboard.

Menu bar

By clicking on the symbols in the menu bar at the top of the screen, the following functions are available:

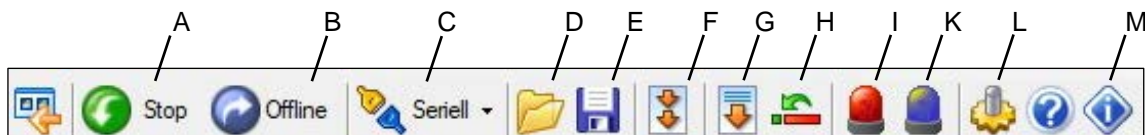

A Establish communication

The two symbols "Start" or "Stop" either start or stop the communication.

B Offline mode

This symbol can be used to switch to offline mode.
In this mode, the service software can be started without having to be connected to the control unit of the system.
The settings can then be saved in a file.

C Communication type

This symbol sets the type of communication.

D Transfer parameter values to the control unit

With this symbol, previously saved parameters can be transferred to a control unit. Alternatively, the set parameters can be viewed using the "offline mode".

(see chapter 6.1.6 , section "*Transfer parameter values to the control unit*")

E Save parameter values

With this symbol, all functions set on the control unit are saved in a file.
(See chapter 6.1.6 , section "*Saving parameter values of a control unit*")

F Transfer the programme to the control unit

With this symbol, a firmware can be transferred to the control unit. To do this, navigate to the corresponding "*dwn file*".

(See chapter 6.1.6 , section "*Transferring the firmware to the control unit*")

G Transfer data to the control unit

With this symbol, all parameters changed with the help of the service software are transferred to the control unit.

H Reset control unit

This symbol initializes a restart of the control unit.

I Current errors

This symbol opens a view in which the current errors of the system can be viewed.

K Error memory

This symbol opens a view in which all errors that have occurred so far are listed with the time of the first and last occurrence.

L Settings

This symbol leads to the settings.

The language can be selected here

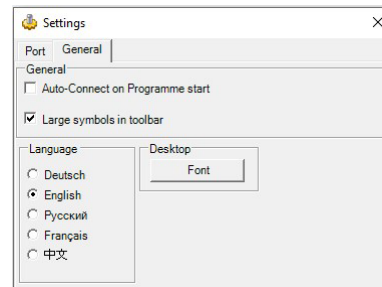
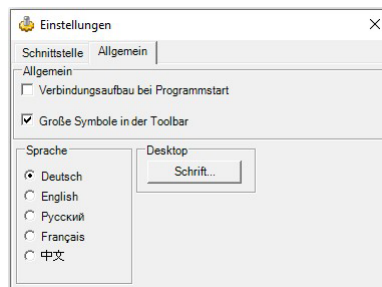

M Info

This icon opens a window with information about the service software.



Overview

This part of the interface provides information on the following points:

- Connection status of the display: green = connected / red = not connected
- Connection status of the BMS: green = connected / red = not connected
- Brake switch activated: green = active / red = not active
- Reverse switch activated: green = active / red = not active

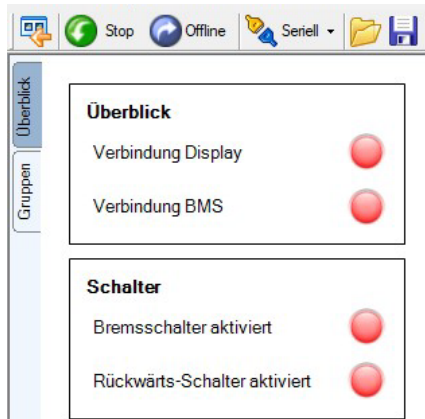

Parameter settings

This part of the interface offers various setting options. These are divided into different tabs whose functions are described in detail in the section "Make parameter settings" in chapter 6.1.6 *Functions of the Configuration Suite*.

Status bar

- Bottom left: Connection status display
- Bottom right: Display of any errors that may have occurred



Tooltips

The service software offers a so-called tooltip function. If the mouse pointer is moved to a corresponding position, a corresponding tooltip appears and provides information on the function and setting options.

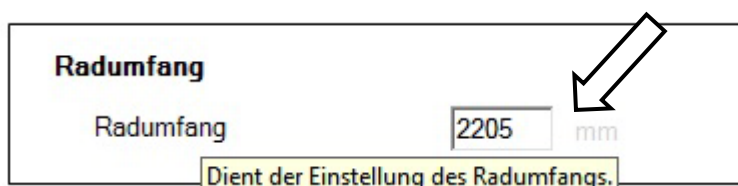

6.1.6 Functions of the Configuration Suite

This chapter gives an overview of the functions of the Configuration Suite.



The prerequisite for using the functions is an active communication link to the control unit (see chapter 6.1.4)

Transferring the firmware to the control unit

The firmware is transferred to the control unit as follows:

- Click on the "**Transfer program to the control unit**" symbol.
(see menu bar [F])
- In the following dialogue "Select" Browse

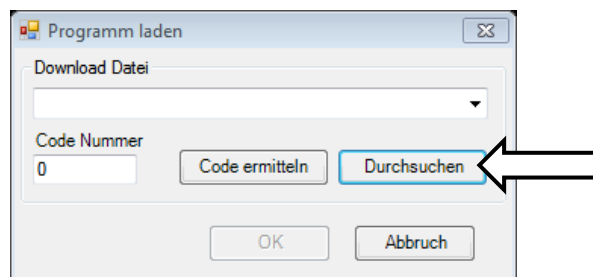

Another window opens.

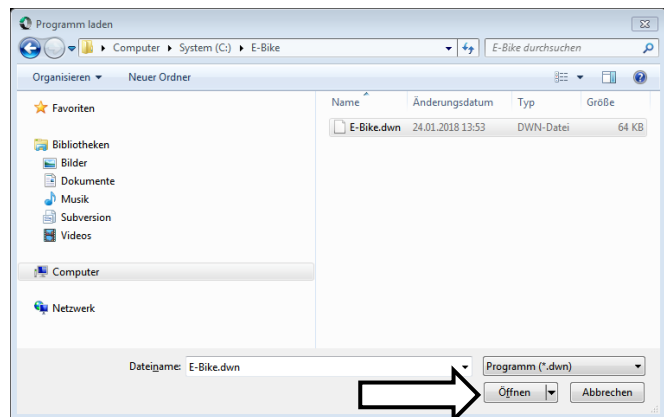

- Navigate to the firmware to be transferred and select "**Open**". (Firmware files have the extension ".dwn")
- Confirm with "**OK**".
A progress bar appears during the transfer. After successful transfer, the system is automatically restarted (see "Reset control unit").



While an update is running, the power supply must always be ensured!

The controller does not communicate with the battery during an update. However, some batteries switch off the power supply if there is no communication with the controller. As a result, the update fails. Information on how to avoid this can be found in the instructions provided by the battery manufacturer.

Transfer parameter values to the control unit

Parameter values are transferred to the control unit as follows:

- Click on the "**Transfer parameters to the control unit**" symbol (see menu bar [D])

Another window opens.

Navigate to the parameter file to be transferred and select "**Open**".
(Parameter files have the extension ".hzc")

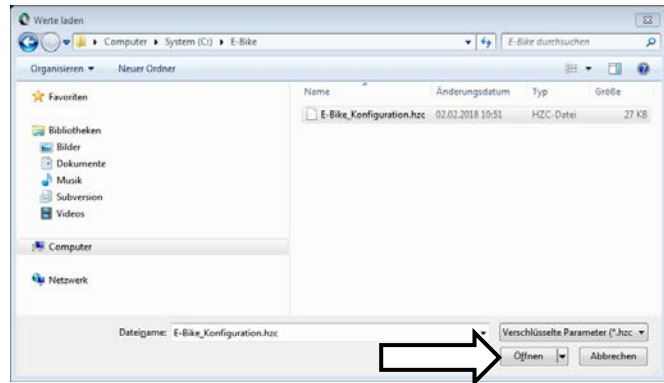

- Click on the symbol "**Transfer data to the control unit**" (see menu bar [G]).
- Click on the "**Reset control unit**" symbol (see menu bar [H])

Alternatively, the "**Reset control unit**" symbol can be clicked immediately. You will then be asked whether the parameter values should be saved in the control unit. Confirm this with "**OK**".

Save parameter values of a control unit

Parameter values of a control unit are saved as follows:

- Click on the "**Save parameter values**" symbol click on (see menu bar [E])

Another window opens.

- Navigate to the location where the parameter file is to be saved.
- Assign a unique and, if possible, self-explanatory file name and confirm with "**Save**". The parameter file is now saved at the selected location under the assigned file name.

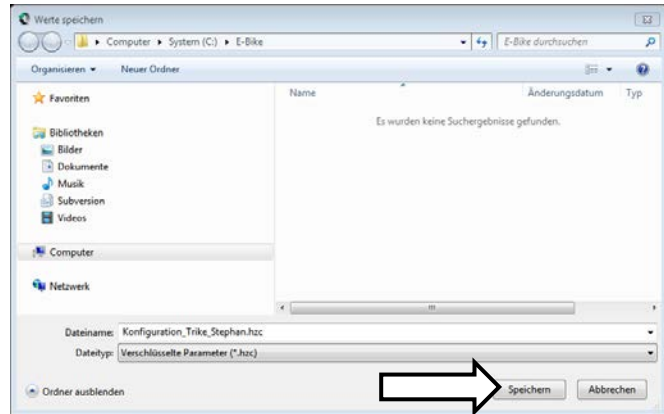

Make parameter settings

In the "Parameter settings" view the available settings are divided into tabs. In the following sub-chapters, the setting options are presented. The following applies to each change of the settings:

- Click on the "**Transfer data to control unit**" icon (see menu bar [G])
This transfers all changes made to the control unit.
- Click on the "**Reset control unit**" symbol (see menu bar [H])
This resets the system.

6.1.6.1 General" tab

Motor calibration

Motor and control always form a fixed pairing. In order to match the motor and controller to each other, each controller must be calibrated once to the respective motor with which it is paired.

To do this, the procedure "Motor calibration" must be carried out.

In systems with several motors, this procedure must be carried out for each pairing of motor and control unit.



A new motor calibration is always necessary if, for example, a motor or a control unit is exchanged due to repair of a system, resulting in a new pairing of motor and control unit.

Only a new motor calibration ensures the proper cooperation between the motor and the control system!

⚠ CAUTION	Rotating parts
	<p>The motor rotates during calibration! Danger of injuries due to rotating drive wheels</p> <ul style="list-style-type: none"> > Position the vehicle so that driven wheels can turn freely > Never sit on the vehicle during calibration

NOTICE



The following conditions must be fulfilled so that the calibration can be carried out correctly and is not falsified:

- > Brake disks must not drag
- > Prescribed tightening torques of the wheel nuts must be observed

For further information, please refer to the technical information "*F_21_004_e_07_21_ED_CPS_ExperienceCalibration*".

- Select "Perform calibration".
The motor will now start to rotate!
- Wait for the motor to stop

Wheel circumference

In order for the system to maintain the correct operating values and their limitations, the circumference of the driven tyre must first be set. The specification is in mm.

NOTICE



An incorrectly adjusted wheel circumference can cause undesirable or even impermissible operating conditions.

These can be:

- excessive speed
- reduced braking effect
- reduced drive power

As already mentioned in chapter 2 "Warnings and safety", the sole responsibility for compliance with applicable laws or directives when using electrically assisted vehicles lies with the operator.

6.1.6.2 "Display" tab

- Select the display installed in the system under "**Display type**".

For each support level, the maximum power provided by the motor can be set here. The information is given in %.

There are differences depending on whether a torque or speed sensor is installed.

If a speed sensor is installed, the maximum assistance to be set is 100% and refers to the maximum motor power.

Example: "Support level 1" >> set value 20%.

The motor then supports with 20% of its maximum power when this level is selected.

If a torque sensor is installed, the value is adjustable up to 1600% and refers to the torque applied by the driver.

Example: "Support level 1" >> set value 800%.

The motor then assists with an additional 800% of the torque contributed by the driver when this level is selected.

6.1.6.3 "Battery" tab

- Select the battery installed in the system.

6.1.6.4 "Sensors" tab

- Select the bottom bracket sensor installed in the system at "**Torque/Speed Sensor Type**".
- In addition, the upper and lower reference voltage of the installed throttle grip can be adjusted and the current voltage can be read out.

6.1.6.5 "Functions" tab

Two-motor configuration

Here you must set whether the system is operated with one or two motors.

If the system is equipped with only one motor, select "**Single Motor**" under "**Primary or Secondary Operation**".

With two motors, one control unit is configured as primary and the other as secondary.

In a primary-secondary system, the control unit with the interface connection must always be the primary control unit (see wiring diagram).



The following settings must be made in both the Primary and Secondary control units and must be identical:

- Wheel circumference
- Speed limit

Speed limit

The speed limit is switched on with the selection field "**Limits activated**". In addition, a value must be entered under "**Torque/speed sensor**". From this value on, the support by the motor stops during operation.

According to the DIN EN 15194 standard, the values for the limitations are:

- Torque/speed sensor: max.25 km/h
- Starting aid: max.6 km/h
- Reversing: max.6 km/h

If a value above this limit is entered, the control unit automatically goes into error mode.

Torque- / rotation sensor

- The "gradient of rise" determines the time in which the torque input by the sensor reaches the maximum value.
The gradient should not be higher than **1000 Nm/s!**
- The "return gradient" determines the time in which the torque input by the sensor reaches zero after the pedaling has stopped. This value can be used to regulate the so-called "push-back".
The return gradient must be at least **500 Nm/s** and should not be selected higher than **2000 Nm/s!**

	<p>Safety relevant setting</p> <p>This value is safety-relevant according to DIN EN 15194. This value must not be changed arbitrarily!</p>
---	---

Starting/push aid

- Starting aid:
The starting aid is switched on with the selection field "**Starting aid activated**".
In addition, a value must be entered under "**Speed limit → Starting aid**". From this value onwards, the support by the motor is interrupted when starting up.
The gradient of rise must not be selected higher than max. **1000 Nm/s!**
The return gradient must be at least **500 Nm/s** and must not be selected higher than **2000 Nm/s!**

	<p>Safety relevant setting</p> <p>This value is safety-relevant according to DIN EN 15194. This value must not be changed arbitrarily!</p>
---	---



- Pushing aid:
If this function is activated, the assistance from the throttle grip only starts after the system registers a forward movement of the motor.

Reversing

With the selection field "**Reversing allowed**", the function for reversing can be activated. The prerequisite is that a button for reversing is installed on the vehicle. When this button and the throttle handle/thumb are pressed simultaneously, the vehicle drives backwards.

The gradient of rise must not be chosen higher than **1000 Nm/s!**



The return gradient must be at least **500 Nm/s** and must not be selected higher than **2000 Nm/s!**

 CAUTION 	<p>Safety relevant setting</p> <p>This value is safety-relevant according to DIN EN 15194. This value must not be changed arbitrarily!</p>
--	--

Motor

- Limitation of continuous power:

This field displays the maximum continuous rated power of the motor.

 CAUTION 	<p>Safety relevant setting</p> <p>This value is safety-relevant according to DIN EN 15194. The total system must not exceed a rated continuous power of 250W. This means that in a primary/secondary system, the power limit of the primary and secondary motor is set to 125W each!</p>
---	---

- Direction of rotation

Sets the direction of rotation of the motor.

6.1.6.6 "Maintenance" tab

(see dashboard 1.12 and following)

Under the "Maintenance" tab, you can view the operating hours and the odometer of the controller as well as the odometer of the vehicle.

In addition, the vehicle's odometer can be set to a new value. This function is used when replacing a controller on a vehicle already in operation.

6.1.6.7 "Info/Logging" tab

With the function "**Logging**" a further window can be opened. In this window, the course of certain values can be displayed graphically, and the recording of these values can be started.

Read out error

With the help of the dashboard, both current errors and errors that have occurred in the past (error memory) can be viewed.

Among other things, the error number and the time of occurrence are stored.

- Open the error memory with the "**error memory**" function

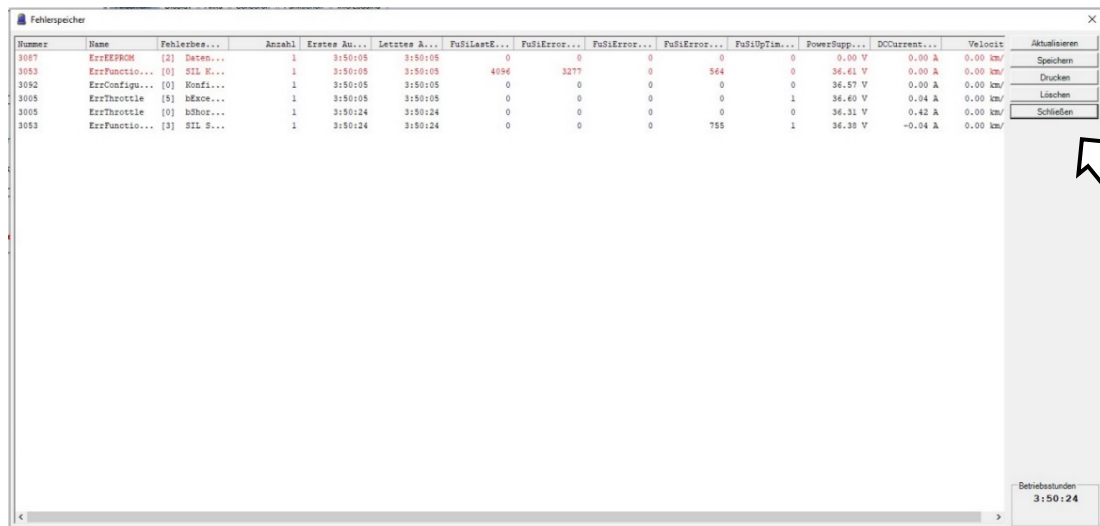

Nummer	Name	Fehlerbehebungsstatus	Anzahl	Erstes Au...	Letztes A...	FuSiLastE...	FuSiError...	FuSiError...	FuSiError...	FuSiUpTim...	PowerSupp...	DCCurrent...	Velocit	Aktualisieren
3087	ErrEEPROM	[2] Daten...	1	3:50:05	3:50:05	0	0	0	0	0	0,60 V	0,00 A	0,00 km/h	Speichern
3083	ErrFunctio...	[0] SIL N...	1	3:50:05	3:50:05	4096	3277	0	564	0	36,61 V	0,00 A	0,00 km/h	Drucken
3092	ErrConfigu...	[0] Konfi...	1	3:50:05	3:50:05	0	0	0	0	0	36,57 V	0,00 A	0,00 km/h	Löschen
3005	ErrThrottle	[5] bKoe...	1	3:50:05	3:50:05	0	0	0	0	1	36,60 V	0,04 A	0,00 km/h	Schließen
3005	ErrThrottle	[0] bKoe...	1	3:50:24	3:50:24	0	0	0	0	0	36,31 V	0,42 A	0,00 km/h	
3083	ErrFunctio...	[3] SIL S...	1	3:50:24	3:50:24	0	0	0	755	1	36,39 V	-0,04 A	0,00 km/h	

Betriebsstunden
3:50:24

The error memory can be operated using buttons on the right edge of the screen.

6.2 Braking and recuperation



The CargoPower drive system offers additional electric braking aids. However, these can in no way replace mechanical braking systems on an electrically assisted vehicle!

- Braking via brake contact

For this function, at least one brake lever with brake contact must be installed on the vehicle. When the brake contact is activated, the drive system switches the motor to generator operation and brakes the vehicle. The braking energy is absorbed by the battery (recuperation). The function must be configured accordingly during initial commissioning.

- Braking with recuperation

When not pedaling, the drive system switches the motor to generator mode at a set speed and brakes the vehicle. The braking energy is absorbed by the battery (recuperation). The function must be configured accordingly during initial start-up.

- Backpedal brake (only with FREE DRIVE system®)

To activate this function, do not pedal for a moment. Then pedal backwards by a defined angle until the Schaeffler alternator generates a counter-torque and thus simulates a back-pedaling brake. The drive system switches the motor to generator operation and brakes the vehicle proportionally to the torque applied when pedaling backwards. The function must be configured accordingly during initial commissioning.

7 Maintenance, repair and cleaning

CargoPower motors RN 111 are basically maintenance-free. The gearboxes are designed for the product's service life, as is the oil filling. Oil does not need to be replaced or topped up.

The electric drive is maintenance-free if used properly and with care.

However, constant operation in a salty environment can promote damage due to corrosion.

A safety inspection must be carried out after every 1000 km of mileage. Check the following:

- Function of the entire electrical system
- Fastening of all cables and parts
- Operating safety of the battery

7.1 Oil filling

In the event of a leak, it may be necessary to fill the motor with fresh oil.

The following steps are necessary for this:

- Position the motor so that the oil drain hole faces downwards.
- Unscrew the oil drain plug on the outer edge of the housing
- **NOTICE** Disassembled screws must not be reused for assembly
- Leave the motor in this position for approx. 1 hour so that it empties completely.
- Position the motor so that the oil drain hole is now facing upwards.
- Fill motor with new oil

Oil grade: Addinol CKT 68

Oil filling quantity: 50 ±1 ml

- After filling with fresh oil, a new screw including O-ring must be mounted

Type: pan-head screw DIN7985-Torx-M5 and O-ring 5x1 FPM-80

(HZM article no.: 001-01-118-13 and 001-12-364-00)

Tightening torque: 5 ± 0.2 Nm

 WARNING	<p>Reduced braking function</p> <p>Dirty brake disks lead to reduced braking power or complete failure of the brakes! This can result in a fall!</p> <p>> Brake disks always keep free of oil or lubricants</p>
--	---

7.2 Repairs and service

Repairs of the motor cannot generally be carried out by the user. In the event of blockages, malfunctions or damage, HEINZMANN must be contacted.

Repairs to the drive system by the user are at the user's own risk and discretion!

⚠ CAUTION	Loose vehicle parts
	<p>When refitting the drive wheel, e. g. after a tyre change, all fastening elements must be properly refitted.</p> <ul style="list-style-type: none">> Refit wheel nuts with the prescribed tightening torque> Insert torque supports designed as levers into the recesses provided in the hub in a fitting, form-fitting and completely backlash-free manner.> Torque supports integrated in the stub axle must be completely free of play.

Private users report a defect to the manufacturer or dealer of the vehicle or contact a service partner:



<https://www.heinzmann-electric-motors.com/kontakt/servicepartner>

Vehicle manufacturers who use the CargoPower drive system use the following service and complaint or complaints use the following service form:



<https://www.heinzmann-electric-motors.com/kontakt/kundenservice>



7.3 Cleaning

⚠ CAUTION	Danger due to unforeseen motor activity and rotating parts
	<p>The motor may start moving unexpectedly if the drive system is left on during cleaning operations. Limbs or items of clothing may be drawn into rotating parts. This can result in injuries.</p> <ul style="list-style-type: none">> Remove the battery before cleaning the vehicle.> Ensure that the contacts of the battery's plug-in connection are not soiled with cleaning agent or similar.> When putting the vehicle back into operation after assembly or repair, position it so that the drive wheel can rotate freely. Only then reinsert the battery and check the proper function of the drive.

The components of the drive system can be cleaned with a soft cloth and the usual cleaning agents or soapy water, but not wet.

NOTICE	The use of a steam jet, high-pressure cleaner or a water jet for cleaning is not permitted. The penetration of water into the control housing, the motor or the electrical plug connections can destroy the units.
	<p>i One exception to this is the alternator of Schaeffler AG is an exception. This may be cleaned wet with a water jet.</p>

8 Spoking the CargoPower motor RN 111

 WARNING	Risk of breakage
	An incorrectly or improperly stored rim can lead to wheel failure and thus accidents. > Spoking the motor into a rim may only be carried out by expert personnel!

8.1 Rims

Only rims with 36 spoke holes can be used.

Punched and eyeleted hollow section rims with french hole pattern and obliquely drilled spoke holes are recommended.

8.2 Spoke diameter

Bore diameter of the spoke holes in the flanges of RN 111,
see technical drawings

880-00-180-* Rear wheel CargoPower motor, HR

880-00-181-* Front wheel CargoPower motor, VR

880-00-182-* Single-sided suspension CargoPower motor, EA

8.3 Spoke lengths

The specification of binding spoke length is not easily possible.

The required length of the spokes depends on:

- Position of the plane of the rim center in relation to the flanges of the motor
- the *effective diameter of the rim (ERD)*

From these values and the dimensions of the motor, the user must determine the required spoke lengths.



Before spoking, obligatory check the correct bolt circle diameter on the basis of the Check the correct bolt circle diameter against the corresponding technical drawing of the motor and measure again at the motor flange.

8.4 Spoke pattern and spoke tensions

Basically, before spoking, the user must clarify which loads the spokes will be exposed to during operation. The following conditions must always be met:

- Spokes must not be completely free of tensile stresses in any operating case
- Basic load + dynamic operating load ≤ max. permissible spoke load

8.4.1 Spoking symmetrical wheels

The CargoPower motor RN 111 are spoked symmetrically.

plane of the rim center = plane of the axle center

The plane of the axle center does not correspond to the center plane between the motor flanges. Consequently, the spokes are of different lengths depending on the motor side and are retracted and tensioned to different degrees.

In the front wheel, the motor flanges deviate to the right from the plane of the rim center when the lacing is symmetrical.

In the rear wheel, the motor flanges deviate to the left from the plane of the rim center when the lacing is symmetrical.

Table for symmetrical spoking:

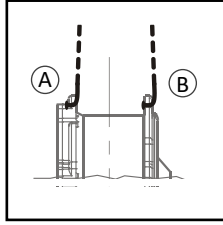
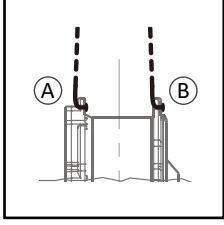
Rim	Threading direction of the spokes *)		Spokes-crossroads	Spoke tension			
	Front wheel VR	Rear wheel HR		Front wheel VR		Rear wheel HR	
				A-side	B-side	A-side	B-side
20"	**) Flange A-side: from outside to inside Flange B-side: from inside to outside	Flange A-side: from inside to outside Flange B-side: from outside to inside	none	1100 N ±20 N	1700 N ±20 N	1,500 N ±20 N	964 N ±20 N
24"			none	800 N ±20 N	1832 N ±20 N	1,500 N ±20 N	955 N ±20 N
26"			1 ×	1100 N ±20 N	1700 N ±20 N	1,500 N ±20 N	952 N ±20 N
28"			1 ×	1100 N ±20 N	1700 N ±20 N	1,500 N ±20 N	951 N ±20 N
*) The key spoke is a leading and left-pointing spoke **) Flange A-side = drive side; flange B-side = brake side							



It is recommended to check the spoke tension after certain mileages of the drive wheels:

1. check: after 200 km Gesamtfahrleistung
2. check: after 500 km
3. check: after 2.000 km
4. check: after 5.000 km

From then on, renewed checks after every 5,000 km.

All information on spokes in this document is indicative only.

To assess the installation situation, a specialist should be consulted to correctly lay out the spokes.

8.4.2 Spoking non-symmetrical wheels

If sufficient installation space is available CargoPower motors RN 111, which are intended for single-sided suspended drive wheels or for two-track vehicles, can also be asymmetrically spoked. In such cases, it is recommended that the spokes are:

level of the rim centre = centre plane between motor flanges

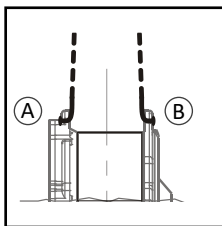

For this case applies:

- Spoke length the same for all 36 spokes
- Spoke tension 1,200 N \pm 20 N
- Threading direction of the spokes on each flange from the outside to the inside, all spoke heads pointing outwards.

8.4.3 Spoke pattern for rear wheel, rim 26" or rim 28", 1× crossed

When spoking in CargoPower motors RN 111 applies as rear wheel drive in rims 26" or 28":

- all spokes are guided through both flanges from the B-side (= side of the brake disk). All spoke heads point towards the brake disk.
- Spokes are crossed 1× (cf. fig.).

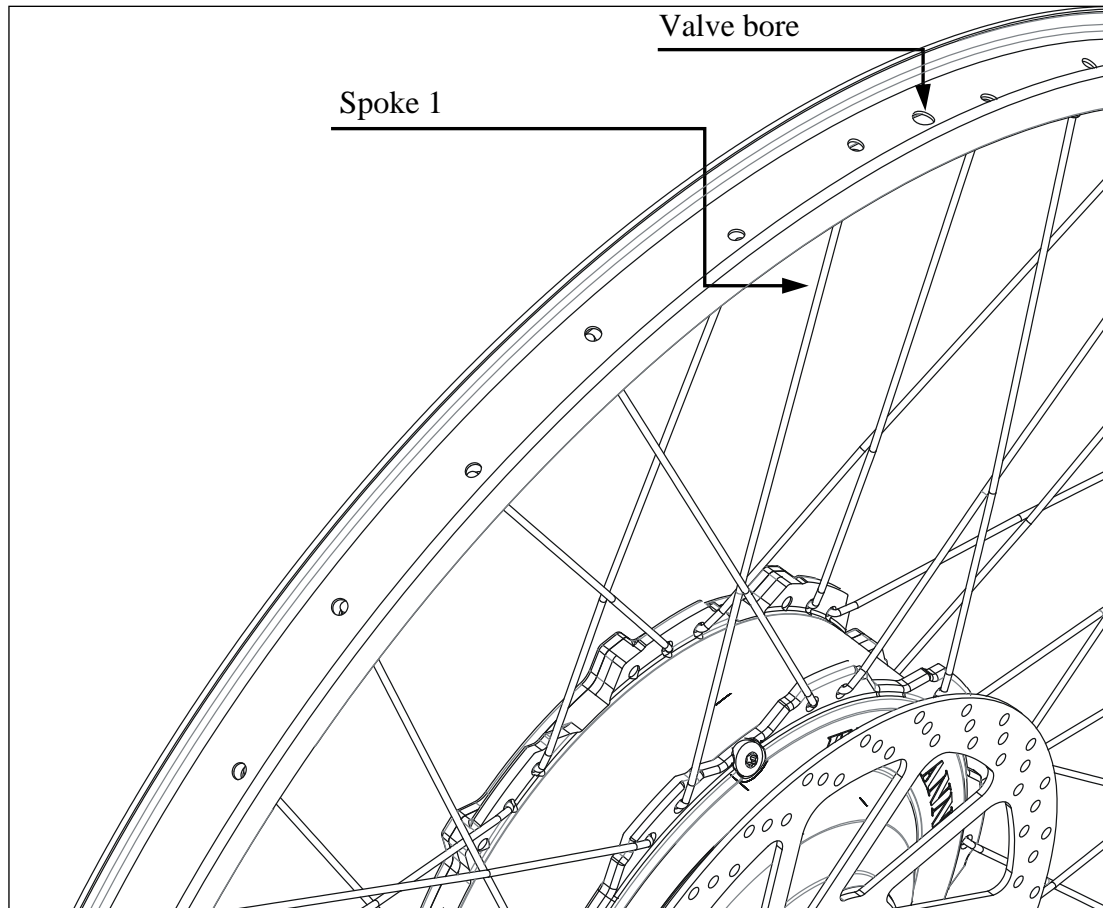

Fig. 4.1 Spoke pattern rear wheel, rim 26" or rim 28", 1× crossed

8.4.4 Spoke pattern for front wheel, rim 26" or 28", 1× crossed

When spoking in CargoPower motors applies as front wheel drive in rims 26" or 28":

- all spokes are guided through both flanges from the A-side (= drive side). All spoke heads point to the A-side.
- Spokes are crossed 1×
- Spoke pattern analogous to that of the rear wheel 26" or 28" (cf. fig.4.1).

8.4.5 Spoke pattern for front wheel, rim 20" or 24", without crossing

When spoking in CargoPower motors as front wheel drive in rims 20" or 24" applies:

- all spokes are guided through both flanges from the A-side (= drive side). All spoke heads point to the A-side.
- Spokes are not crossed (cf. Fig.4.2).

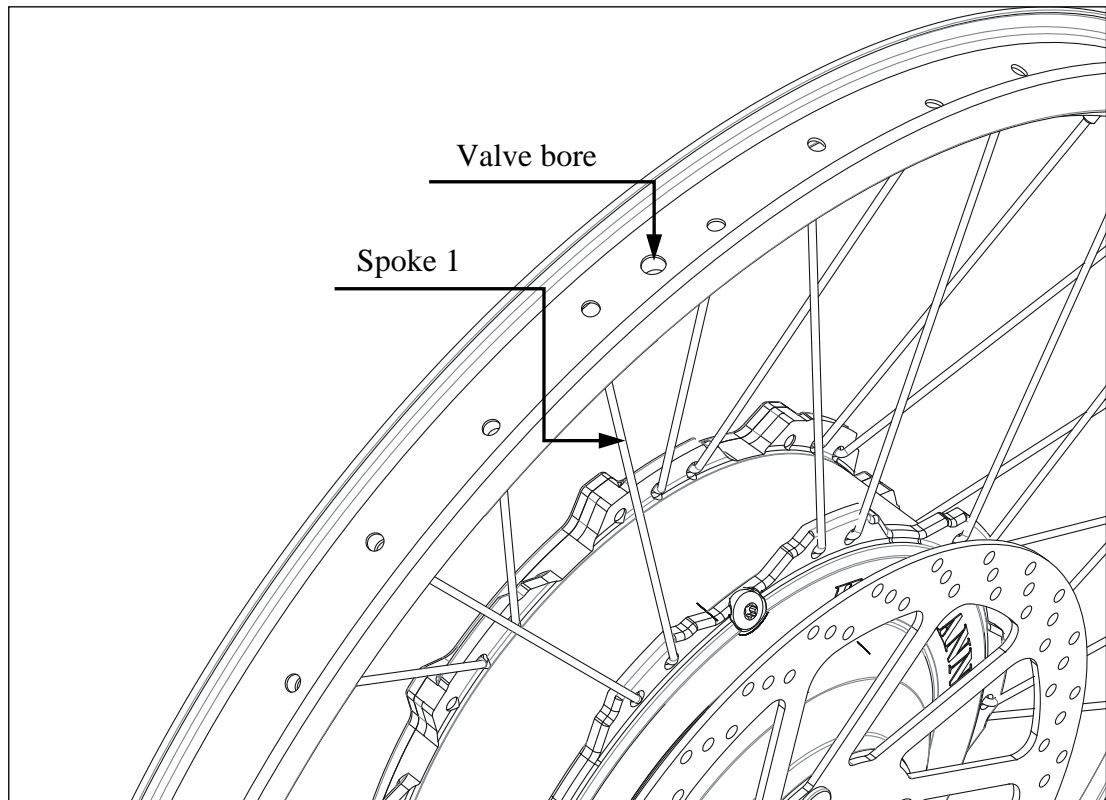

Fig. 4.2 Spoke pattern front wheel, rim 20" or 24", without crossing

8.4.6 Spoke pattern for rear wheel, rim 20" or 24", without crossing

When spoking in motors CargoPower RN 111 as rear wheel drive in rims 20" or 24" applies:

- all spokes are guided through both flanges from the B-side (= side of the brake disk). All spoke heads point towards the brake disk.
- Spokes are not crossed.

Spoke pattern analogous to that of the front wheel 20" or 24" (cf. fig.)

9 Index

axle load	4	drive	
batteries	25, 55	practice.....	4
bolt circle diameter.....	64	reverse.....	58
brake		EMC.....	26
aid	60	encoder disk	18
backpedal.....	60	error memory	59
contact	60	firmware.....	47
brake disk	12, 53, 61	transfer	50
change.....	13	gear selection	36
initial assembly.....	13	generator	33
screw.....	15	helmet	2
cadence	37	high-pressure cleaner	63
CAN		installation.....	38
cable	43	insurance obligations	2
communication	21, 26	light button.....	34
connection	43	light on	34
cleaning	63	logging	59
communication	21	maintenance	61
compatibility.....	41	menu bar	47
complaints	62	motor	
configuration suite		calibration	53
installation	38	direction of rotation	58
setup	39	installation.....	9
controllerbox	7	oil	
damage	42	filling quantity	61
installation position	8	grade	61
CVT-gearbox.....	37	leak.....	5, 12
dashboard	39, 41, 46	operating hours	58
DIN EN 15194	17, 18, 26	parameter	
direction of rotation.....	58	save	52
display	22	setting.....	52
display bar	34	transfer	51
		peripherals.....	17

power button.....	34	starting aid	24, 57
power limitation	58	state of charge / SoC	35
Precote [®]	7, 15	status display.....	49
pressure equalization	5	steam jet	63
pushing aid	57	stub axle	9
recuperation	60	screws	9
regulations	2	tightening torque.....	9
repairs	62	support level.....	35
reset control unit.....	51	threadlocker	33
reverse		throttle grip	23
button.....	24	thumb throttle.....	23
drive.....	24	torque sensor	55
function.....	24	torque support	10
rims.....	64	transmission ratio.....	36
risk of breakage	3, 4, 9, 64	transport	5
RS 232.....	44	two-motor-configuration.....	56
sensor.....	55	tyre circumference	54
service.....	62	USB	
setup	38	cable	42
SoC	35	socket	42
speed limit	56	wheel	
speed sensor.....	18, 55	centre.....	66
splitter.....	43	non-symmetrical	66
spoke.....	64	symmetrical.....	66
bore diameter.....	64	wheel nuts	3, 4, 9, 53, 62
length.....	64	torque	9
tension	66		